

ALBERTA CERVICAL CANCER SCREENING PROGRAM

CERVICAL CANCER SCREENING LEARNING MODULE FOR REGISTERED NURSES

June 23, 2021

Version 2.1

Thank you to all 2017-2019 reviewers of the Cervical Cancer Screening Learning Module for Registered Nurses (RNs).

Thank-you to the following organizations that provided permission to use sections of their resources in this module:

- Alberta Medical Association, Alberta, Canada
- BD (Becton, Dickinson and Company), New Jersey, USA
- Calgary Laboratory Services (now Alberta Public Laboratories), Alberta, Canada
- Centers for Disease Control and Prevention (2003). STD Clinical Slides.
- CervixCheck Manitoba, Manitoba, Canada
- Elsevier Publishing, publisher for Mosby's Guide to Physical Examination
- Family Planning, Queensland, Australia
- National Health Services Cancer Screening Programmes, United Kingdom
- Pap Screen, Victoria, Australia
- Thieme Publishing, publisher of Colposcopy, Cervical Pathology: Textbook & Atlas, 2nd Ed.
- Toward Optimized Practice, Alberta, Canada

Permission Note:

The Saskatchewan Institute of Applied Science and Technology regarding the use of SIAST graphics and content: ©2002, SIAST. No part of the work(s) contained herein may be reproduced or copied in any form or by any means – graphic, electronic, or mechanical, including photocopying, recording, taping of information and retrieval systems – without written consent of the Saskatchewan Institute of Applied Science and Technology.

If you wish to reproduce graphics or content in this module, you must request permission from the original author.

Reference Citation:

Alberta Health Services. (2020). ACCSP Cervical Cancer Screening Learning Module for Registered Nurses. Retrieved from https://screeningforlife.ca/for-health-providers/cervical-screening-information/#rn_pap_module_resources. Calgary, AB: Screening Programs.

For more information, please contact:

Screening Programs
Alberta Cervical Cancer Screening Program
Healthy Living
Population, Public, and Indigenous Health
Alberta Health Services
Holy Cross Site I, 2202 - 2nd Street SW
Calgary, Alberta, Canada T2S 3C1
Phone: 1-866-727-3926
Fax: 1-888-944-3388

TABLE OF CONTENTS

Table of Contents	3
Updates	7
WELCOME	8
Learning Module Purpose and Rationale	8
Recommendations for using the Cervical Cancer Screening Learning Module.....	8
Learning Module Objectives	8
Learning Resources	9
Sequence of Learning Activities	9
Practicum.....	10
Learning Module Completion Schedule.....	13
Learning Module Completion Form	14
SECTION 1: INTRODUCTION	18
Learning Objectives	18
Required Readings	18
Definitions	18
Professional Responsibility and Accountability.....	18
Preceptors' Responsibilities	19
Section 1: Self-Test.....	20
Pre-test	21
SECTION 2: CERVICAL CANCER AND CERVICAL CANCER SCREENING	28
Learning Objectives	28
Natural History	28
HPV and Cervical Cancer	29
Incidence and Mortality Rates	29
Risk Factors	30
Rapid Progression of Cervical Cancer	31
HPV and HPV Vaccine.....	31
High Risk Groups.....	32
Opportunistic Versus Organized Population-Based Cancer Screening.....	32
The Alberta Cervical Cancer Screening Program Overview	33
Alberta Cancer Screening Report.....	35
Screening Participation	36

Recommended Readings..... 37

Section 2: Self-Test..... 38

SECTION 3: CERVICAL SCREENING CYCLE 40

Learning Objectives 40

Initiating Cervical Cancer Screening 40

Women Younger than 21 Years and Aged 21-24..... 40

Women 25-29 42

Screening Interval 42

When to Discontinue Screening 42

Balancing Risks and Benefits..... 43

Limitations of Screening 44

Increased Surveillance..... 45

Discontinuing Screening 45

Who Should Have a Pap Test and How Frequently?..... 46

Exclusions from Pap Testing..... 46

Recommended Readings..... 47

Section 3: Self-Test..... 49

SECTION 4: COUNSELLING AND EDUCATION..... 50

Learning Objectives 50

Reasons Why Women May Avoid Pap Tests 50

Before the Exam 51

During the Exam 52

After the Exam 52

Section 4: Self-Test..... 54

SECTION 5: FACILITATING AN INCLUSIVE ENVIRONMENT..... 55

Learning Objectives 55

Clients with a History of Sexual Abuse 55

Lesbian Clients, WSW and Transgendered Clients 56

Clients with Disabilities..... 59

Clients with Physical Disabilities..... 59

Clients with Learning/Cognitive Disabilities Counseling and Education 59

Clients with a Hearing Impairment..... 59

Vaginismus 60



Recommended Readings.....	60
Suggested Readings.....	61
Section 5: Self-Test.....	62
SECTION 6: HEALTH HISTORY	63
Learning Objectives	63
Health History Review.....	63
Review of Related History	64
Section 6: Self-Test.....	66
SECTION 7: PHYSIOLOGY, ANATOMY, AND ABNORMAL FINDINGS.....	67
Learning Objectives	67
Menstrual Cycle	67
Developmental Changes in the External and Internal Genitalia.....	68
External Genitalia.....	70
Internal Genitalia.....	73
Anatomy of the Cervix as a whole.....	77
Summary Chart: Identifying Normal and Abnormal Cervical Appearances	83
Female Genital Mutilation (FGM)	84
Summary Chart: Discharges, Infections, Ulcers, and Lesions	85
Suggested Readings.....	88
Section 7: Self-Test.....	89
SECTION 8: EXTERNAL AND SPECULUM EXAM	91
Learning Objectives	91
Exam Equipment.....	91
Preparing the Client	91
External Examination	93
When to Refer a Client.....	104
Section 8: Self-Test.....	105
SECTION 9: PAPANICOLAOU TEST	107
Learning Objectives	107
Ideal Conditions for Taking Pap Tests.....	107
Sampling Areas.....	107
Liquid Based Cytology Collection Instructions.....	107
Equipment for Pap Test	108



Pap Test Procedure	108
Pap Test Sample: Submission Procedures	112
Recommended Readings.....	115
Section 9: Self-Test.....	116
SECTION 10: PAP TEST RESULTS	117
Learning Objectives	117
The Bethesda System.....	117
Unsatisfactory Pap Test Results	117
Abnormal Pap Test Results.....	118
Management of Abnormal Pap Test Results	121
Recommended Readings.....	124
Section 10: Self-Test.....	125
Post-Test.....	127
Case Studies.....	134
GLOSSARY	139
REFERENCES.....	148
APPENDIX 1: RECOMMENDED POLICIES.....	152
APPENDIX 2: ASSESSMENT TOOLS	154
Pap Test Skills Checklist.....	154
Client Satisfaction Survey	157
Practicum Audit Form.....	159
APPENDIX 3: ANSWER KEY PRE-TEST AND POST-TEST.....	161
APPENDIX 4: ANSWER KEY CASE STUDIES.....	170
APPENDIX 5: EVALUATION.....	175
Learning Module Evaluation.....	175
Practicum Evaluation	177



Disclaimer and Terms of Use

The information in the Learning Module is public information and is not individualized medical advice. It is not intended, nor should it be used, as a substitute for any kind of professional medical advice, diagnosis or treatment.

All copyrights are reserved by Alberta Health Services Screening Programs (herein referred to as AHS SP). No part of the Learning Module may be reproduced, distributed or transmitted in any form or by any means, or stored in a data base or retrieval system, without the prior written consent of AHS SP, unless such reproduction, transmission, or storage is solely for the purpose of using the Learning Module for personal use only. **For information regarding permissions, please contact AHS SP at 1-866-727-3926 or <http://screeningforlife.ca/contact-us>.**

AHS SP makes no representations or warranties in relation to the contents of the Learning Module. While AHS SP strives for accuracy, it is possible that the information in the Learning Module may contain errors and omissions. AHS SP reserves the right to review, update, and/or amend the Learning Module, from time to time, in its sole discretion, without recourse from any user of the Learning Module. All references to the Learning Module herein shall include any amended Learning Module.

AHS SP shall not be liable for, any personal injury, damage or claim, of any kind whatsoever, suffered by any other person relating in any way to use of the Learning Module or the information contained therein.

Updates

The Learning Module has been updated to reflect current (2016) cervical cancer screening clinical practice guidelines. Towards Optimized Practice, Cervical Cancer Screening Clinical Practice Guideline 2016: <https://top.albertadoctors.org/CPGs/Lists/CPGDocumentList/Cervical-Cancer-Screening-Summary.pdf>

AHS SP may update the Learning Module from time to time. Updates will be posted on https://screeningforlife.ca/for-health-providers/cervical-screening-information/?d=2#rn_pap_module_resources.

AHS SP is not responsible or liable for any other Learning Module modifications. For example, if a department or clinic/agency creates and updates specific material (e.g. policies and procedures), do not include them in this Learning Module but rather create a separate folder for such documentation.

Version	Date Updated	Version	Date Updated
1.0	March 31, 2020		
2.0	July 7, 2020		
2.1	June 23, 2021		



WELCOME

Welcome to the AHS SP revised Cervical Cancer Screening Learning Module for Registered Nurses (formerly known as RN Pap Test Learning Module 2012). The Learning Module is a continuing education resource for the Alberta Cervical Cancer Screening Program (ACCSP). The ACCSP is coordinated by AHS SP in partnership with healthcare providers.

Learning Module Purpose and Rationale

The Learning Module's purpose is to provide Registered Nurses (RNs) with knowledge and skill-based learning activities that may be used to develop and/or maintain competency in performing cervical cancer screening.

- RNs are encouraged to use the Learning Module for their self-directed learning and as an ongoing resource to review as required.
- Employers and Preceptors are encouraged to utilize the Learning Module as a continuing education resource to support RNs in developing and maintaining competency in cervical cancer screening.
- While this module is developed for RNs, other health professionals can utilize it as a continuing education resource.

Recommendations for using the Cervical Cancer Screening Learning Module

All RNs practicing in Alberta whose position requires them to perform Papanicolaou (Pap) tests are required to complete the *Cervical Cancer Screening Learning Module for Registered Nurses*.

For the RN who has previously completed education and demonstrated competence in Cervical Cancer Screening, learning module completion is recommended. Completion of the practicum would not be required, unless deemed necessary to regain or improve skills.

RNs are recommended to perform at least 12 satisfactory Pap tests per year to maintain competency.

RNs would need to discuss with their Employer whether the Learning Module is relevant to their practice setting and the Employer's expectations.

The *Cervical Cancer Screening Learning Module for Registered Nurses*, developed by AHS SP, can be used by RNs and their Employers to support the attainment of competence in the performance of this restricted activity.

Learning Module Objectives

On completion of the Learning Module theory and practicum, the learner will be able to:

1. Demonstrate an understanding of cervical cancer and the guidelines of cervical cancer screening in Alberta.
2. Demonstrate an understanding of counselling and teaching strategies before, during and after an external/internal exam (speculum and Pap test).
3. Demonstrate an understanding of the learning, counselling, and communication needs of clients with special considerations.

4. Demonstrate an understanding of normal and abnormal female pelvic anatomy and physiology.
5. Demonstrate an understanding of, and competently perform a health history and an external/internal exam (speculum and Pap test) with women across the lifespan.
6. Demonstrate an understanding of abnormal findings, such as STI, and referral for appropriate follow-up.
7. Demonstrate an understanding of the guidelines for management of women based on Pap test results (Bethesda System) and in some circumstances, human papillomavirus (HPV) reflex test results.
8. Demonstrate an understanding of key medico legal issues such as quality documentation, client confidentiality, informed consent, negligence and accountability.

Learning Resources

- **Learning Module Content:** Sections 1 to 10, Tests, Glossary, References, and Appendices.
- **Required Readings:** RNs are required to read the College and Association of Registered Nurses of Alberta (CARNA) [Registered Nurse Role in Cervical Cancer Screening Practice Advice 2018](#), and [ACCSP Cervical Cancer Screening Provided by Registered Nurses Guideline](#).
- **Recommended Readings:** As listed in relevant sections. Note: Many of the recommended readings are links to other online documents. It is recommended that RNs open and read the information directly from the website links versus printing paper copies that may potentially become outdated.
- **Suggested Readings:** As listed in relevant sections. These readings are provided to further supplement the RN's knowledge. Note: Many of the suggested readings are links to other online documents. It is recommended that RNs open and read the information directly from the website links versus printing paper copies that may potentially become outdated.
- **Assessment Tools:** See [Appendix 2: Assessment Tools](#) for the Pap Test Skills Checklist, Client Satisfaction Survey, and instructions for Pap test audit form.
- **Preceptor:** As arranged by each Employer and/or practice setting.

Sequence of Learning Activities

RNs are required to be partnered with a **Preceptor** (RN, Nurse Practitioner, or Physician experienced and competent in well-woman care and performing Pap tests), who will oversee the educational process and be willing to participate in the following learning activities. It is recommended that the RN utilize the [Learning Module Completion Form](#) found on page 14 to record progress through the Learning Module.

1. **Theory Component:** The RN completes a self-paced review of Learning Module content, reads the required and recommended readings, and consults with their Preceptor as needed.
2. **Theory Assessment:** The RN completes the written assessments (Pre-Test, Post-Test and Case Studies) from the Learning Module content and submits them to their Preceptor for review. Answer Keys to facilitate feedback and discussion are available in [Appendix 3: Answer Key Pre-Test & Post-Test](#) and [Appendix 4: Answer Key Case Studies](#).
3. **Practicum Component:** The practicum involves observing a Preceptor performing Pap tests. The RN then conducts Pap tests both supervised and unsupervised, until deemed competent.

4. **Practicum Assessment:** The RN, the Preceptor, and/or practice setting assess the RN's Pap test skills using the Assessment Tools found in [Appendix 2: Assessment Tools](#).
5. **Evaluation:** The RN, the Preceptor, and the Employer are encouraged to complete the *Learning Module & Practicum Evaluation Forms* in [Appendix 5: Evaluation](#).



For the RN who has previously demonstrated education and competence in cervical cancer screening, completion of the Learning Module is recommended but not required. RNs who require retraining are recommended to complete the practicum (Step 1 may be omitted).

RNs are recommended to perform at least 12 satisfactory Pap tests per year to maintain competency.

Practicum

Step 1: Observe

It is suggested that the RN observe the Preceptor conduct 5 Pap tests.

Step 2: Supervised Practice

It is suggested that the RN conduct approximately 10-12 supervised Pap tests within 2 months.* The Preceptor may utilize the [Pap Test Skills Checklist](#) found in Appendix 2: Assessment Tools.

Step 3: Unsupervised Practice

It is suggested that the RN conduct 5-30 unsupervised Pap tests within 2 months.* The RN may utilize the [Client Satisfaction Survey](#) found in Appendix 2: Assessment Tools.



*The number of Pap tests that the RN completes during the practicum may range from 15-30 however it is recommended that emphasis be placed on high quality learning experiences rather than the total number of Pap tests completed. **It is recommended that the RN observe and demonstrate until she/he feels comfortable and confident and is deemed competent by the Preceptor.**

Step 4: Review

- a. **Clinical assessment of competency by Preceptor:** Review and discuss the supervised Pap tests and the completed [Pap Test Skills Checklist](#) with Preceptor.
- b. **Unsupervised practice assessment:** Review and discuss the unsupervised Pap tests and the [Client Satisfaction Surveys](#) with Preceptor.
- c. **Review Pap test specimen adequacy rate:** Review and discuss the Pap test specimen adequacy rate** of all supervised and unsupervised Pap tests conducted during the practicum period with Preceptor and/or Employer. Adequacy rate can be calculated by compiling all Pap test result letters and counting the number of unsatisfactory Pap tests. Divide the number of unsatisfactory Pap tests by the total number of Pap tests conducted and multiply by 100 to find the adequacy rate (%).



A worksheet can be used to keep track of all Pap tests conducted during the practicum period (see [Practicum Audit Form](#) in **Appendix 2: Assessment Tools**).

****Specimen adequacy rates differ between the labs** based on the type of liquid based cytology that is used and the process for analyzing specimens within the lab.

The Pap Test Specimen Adequacy Rate for Alberta Precision Laboratories is <1% (of tests are unsatisfactory).

The Pap Test Specimen Adequacy Rate for DynaLIFE is <2% (of tests are unsatisfactory).

RNs submitting Pap test samples to APL will receive a report (biannually) should their adequacy rate fall below the threshold established by the lab for that reporting period. It is recommended that RNs share these reports with their Employer/practice setting. Employers and practice settings must ensure steps are taken to help the RN increase adequacy rates as required. A sample of the APL letter is below.

- d. **Discuss all components of Learning Module with Preceptor and complete any additional theoretical and/or practical learning.**



June 25th, 2019

Dear Physician:

Alberta Public Laboratories Cytopathology frequently monitors the rate of Unsatisfactory Pap tests we receive in the laboratory. Our intent is to work with “Pap takers” who have an elevated rate of unsatisfactory Paps and drop it significantly so the patients do not have to come back for repeat Pap tests.

There are many reasons why Pap samples are “Unsat”. The common ones are incompatible lubricants used by both doctor and patient, faulty technique, and post-menopausal status. Less often we have received empty vials with only preservative and NO patient sample.

Please be reminded that lubricant jelly interferes with processing of Liquid-based Cytology specimens. It is recommended to use no lubricant or if necessary due to patient discomfort, use it sparingly, making sure not to let it contact the surface to be sampled. Petroleum based lubricants are insoluble in the PreservCyt collection media and interfere with cell filtration during specimen processing.

It is also advisable to remind patients to refrain from the use of personal lubricants, spermicidal jellies or hormonal creams at least 7 days prior to the Pap test.

Our target rate for unsatisfactory Pap test samples is <1%. Currently this rate is 1.6%. We would appreciate an opportunity to work with you so we can bring this number down.

The recommended Pap test collection procedure is accessible on the Calgary Laboratory Services website at:

<http://www.calgarylabservices.com/files/LabTests/APCyto/ThinPrepGuide.pdf>

In order to ensure correct patient identification please use the following guidelines:

a) ensure that the patient PHN is updated at each office visit, b) the patients full name on the requisition matches that on the container and c) you have used the Calgary Laboratory Services physician office stamp for accurate return of patient reports to you.

If you have questions please do not hesitate to contact us.

Sincerely,

Dr. Steve Gorombey
Specialty Group Leader Cytopathology
Alberta Public Laboratories
Ph: 403-943-4328
E-mail: steve.gorombey@albertapubliclabs.ca

Unsatisfactory Pap Test Letter, Alberta Public Laboratories (2019)



Learning Module Completion Schedule

Upon successful completion of both the theoretical and practicum components and assessments, the RN will have fulfilled the competency requirements recommended in the Learning Module.

A suggested time schedule for completing the Learning Module is below. Please note the hours are approximate as everyone will learn at their own pace.

As well, see *Learning Module Completion Form* on the following page. The original form should be kept by the RN, with copies given to the Employer and the Preceptor to indicate the completion of all Learning Activities.

Components	Time (in hours)										
	<1	1	2	3	4	5	6	7	8	9	10
Theory											
Read Section 1											
Complete Pre-Test											
Read Section 2-10 Read Learning Resources											
Complete Post-Test (85%)											
Complete Case Studies (85%)											
Discuss Test/Cases with Preceptor											
Complete any additional learning needs (as needed)											
Register as a New Provider with appropriate lab											
Practicum											
Step 1: Observe Preceptor conduct Pap tests Step 2: Conduct consecutive Preceptor supervised Pap tests Step 3: Conduct consecutive unsupervised Pap tests with client satisfaction surveys											
Step 4a: Clinical assessment of competency by Preceptor											
Step 4b: Review client satisfaction surveys (with Preceptor and/or Employer)											
Step 4c: Review adequacy rates of Pap tests (with Preceptor and/or Employer)											
Step 4d: Discuss all components of Learning Module with Preceptor and complete any additional theoretical and/or practical learning											
Re-assessment of any activity if required (as needed)											
Evaluation											
Complete Learning Module Evaluation Survey											
Complete Practicum Evaluation Survey											
On-going (annual review)											
Track Pap test adequacy rates as required by Employer											
Update competency yearly or as required by Employer											



Learning Module Completion Form ([download](#))

Date	RN Name
CARNA #	Employee #
Employer	
Supervisor/Manager Name	
Preceptor Name	
<input type="checkbox"/> Copy for RN <input type="checkbox"/> Copy for practice setting/Employer <input type="checkbox"/> Copy for Preceptor	

Activity	Requirements/ Tool	Date Completed	Comments/Score	Assessed by:
THEORY				
Read ACCSP Cervical Cancer Screening Provided by Registered Nurses Guideline , and CARNA Registered Nurse Role in Cervical Cancer Screening Practice Advice 2018	Complete			
Read Section 1: Content	Complete			
Read/View Section 1: Learning Resources	Complete			
Complete Pre-Test	Complete			
Read Sections 2-10: Content	Complete	Sec 2		
		Sec 3		



Activity	Requirements/ Tool	Date Completed	Comments/Score	Assessed by:
		Sec 4		
		Sec 5		
		Sec 6		
		Sec 7		
		Sec 8		
		Sec 9		
		Sec 10		
Review Sections 2-10 Learning Resources	Complete	Sec 2		
		Sec 3		
		Sec 4		
		Sec 5		
		Sec 6		
		Sec 7		
		Sec 8		
		Sec 9		
		Sec 10		
Complete Post-test	85% See Appendix 3: Answer Key Pre- test & Post-test			
Preceptor review	Complete			
Complete Case Studies	85% See Appendix 4: Answer Key Case Studies			
Preceptor review	Complete			



Activity	Requirements/ Tool	Date Completed	Comments/Score	Assessed by:
Results discussion with Preceptor	Complete			
Complete any additional learning needs	Complete			
Register as New Provider with appropriate lab	Complete See Section 9: Papanicolaou Test			
PRACTICUM				
Observe Preceptor conduct Pap tests	*5 clinical visits			
Conduct consecutive supervised Pap tests	*10-20 supervised Pap tests within 2 months			
Conduct consecutive unsupervised Pap test visits	*5-30 unsupervised Pap tests within 2 months			
Clinical assessment by Preceptor	100% See Pap Test Skills Checklist in Appendix 2			
Review adequacy rates of Pap tests performed during practicum period (with Preceptor and/or Employer)	**15-50 Pap tests with acceptable adequacy rate (per lab requirement)			
Review Client Satisfaction Surveys with Preceptor	Complete			



Activity	Requirements/ Tool	Date Completed	Comments/Score	Assessed by:
Discuss all components of Learning Module and complete any additional theoretical and/or practical learning	Complete			
Re-assessment of any activity if required	Complete			
EVALUATION				
Complete Evaluation of Learning Module	Complete 1 copy for Employer 1 for AHS-CSP See Learning Module Evaluation in Appendix 5			
Complete Evaluation of Practicum	Complete 1 copy for Employer See Practicum Evaluation in Appendix 5			



*The number of Pap tests that the RN completes during the practicum may range from 15-30 however it is recommended that emphasis be placed on high quality learning experiences rather than the total number of Pap tests completed. **It is recommended that the RN observe and demonstrate until she/he feels comfortable and confident and is deemed competent by the Preceptor.**

****Specimen adequacy rates differ between the labs** based on the type of liquid based cytology that is used and the process for analyzing specimens within the lab.

The Pap Test Specimen Adequacy Rate for Alberta Public Laboratories is <1% (of tests are unsatisfactory).

The Pap Test Specimen Adequacy Rate for DynaLIFE is <2% (of tests are unsatisfactory).



SECTION 1: INTRODUCTION

Learning Objectives

Upon completion of this Section, the learner will be able to:

1. Describe the Learning Module's rationale and purpose.
2. Discuss the responsibilities of RNs, Employers, and Preceptors related to RNs performing cervical cancer screening.
3. List the learning objectives, types of learning resources, activities, and recommended schedule for completing the Learning Module.

Required Readings

To support your practice, please ensure you read the following documents:

1. [ACCSP Cervical Cancer Screening Provided by Registered Nurses Guideline.](#)
2. [CARNA Registered Nurse Role in Cervical Cancer Screening Practice Advice.](#)

Definitions

Cervical Cancer Screening: Comprehensive screening process that tests eligible women for abnormal or precancerous cervical cells inclusive of providing the necessary follow-up.

Papanicolaou (Pap) test: A test in which cells are removed from the cervix and examined under a microscope to find abnormal changes.

Professional Responsibility and Accountability

The Pap test is a cervical cancer screening activity designed to be utilized for asymptomatic women. Symptomatic women and/or those at high risk will need to be screened/evaluated on an individual basis.

It is important for RNs to have broad clinical experience in conducting Pap tests. The RN must see a variety of clients to be proficient in determining normal from abnormal cervical variations. An RN who only observes healthy young clients may not have the skills to properly assess a multiparous client who may have many cervical lacerations etc.

The RN should make it clear to the client that the Pap test does NOT constitute a full periodic health assessment. The client needs to see her Physician or Nurse Practitioner for a complete periodic health assessment which may include a physical exam, risk assessment and screening for other disease processes. Periodic health assessments should not be annual but at intervals according to risk (including age).

It is strongly recommended that the Learning Module become a segment within comprehensive Employer policies and approach to providing holistic women-centered services, for example: Sexually Transmitted Infections (STI) testing. If the population that the RN serves has a high incidence of STI, the Employer may consider RN continuing education related to performing STI tests. STI continuing education should be considered in combination with Pap test continuing education.

RNs, Employers, and Preceptors have shared responsibilities related to RNs performing cervical cancer screening and are required to:

- **Provide adequate time, resources, preceptorship opportunities, and facilities** to ensure that RNs are adequately educated (both initially and on an ongoing basis) to provide quality cervical cancer screening.
- **Ensure that there is an explicit relationship between the RN and a Physician or Nurse Practitioner in their practice setting** to ensure follow-up of all Pap test results, including referral to another healthcare professional when required.
- **Develop policies and procedures related to RN cervical cancer screening** for their institution, agency, or clinic (see [Appendix 1: Recommended Policies](#)).
- **Participate in ongoing monitoring of Pap test adequacy rates** (see [Appendix 2: Assessment Tools](#)).
- Maintain a record of RN cervical cancer screening education.

Preceptors' Responsibilities

Preceptors who provide cervical cancer screening theory and a practicum experience are required to:

- Be a Registered Nurse, Nurse Practitioner, or Physician.
- Be skilled, experienced and up to date in cervical cancer screening.
- Be able to demonstrate continuing competencies in cervical cancer screening provision (with particular reference to transformation zone sampling, technique, sample preparation, audit of results including adequacy rate).
- Demonstrate good communication and counselling skills.
- Remain current in new developments in cervical cancer screening in Alberta and the [Guideline for Cervical Cancer Screening](#) [Toward Optimized Practice Working Group for Screening for Cervical Cancer (TOP), 2016].
- Have time to provide Preceptor duties such as mentorship, supervision, and review of assessment materials.

Section 1: Self-Test

1. What is the main purpose of the Cervical Cancer Screening Learning Module for Registered Nurses?
2. List 2 responsibilities each for the RN, Employer and Preceptor related to RNs performing Pap tests.
3. Describe 2 ways that you will apply the learning module resources and activities to assist you to increase your competency and skills related to performing Pap tests as an RN.

Pre-test

Complete the following Pre-Test prior to proceeding to Section 2: Cervical Cancer & Cervical Cancer Screening. Answers will be provided after the completion of the Post-Test (which occurs after working through all the Sections).

Instructions for Test Completion

For multiple choice questions, please indicate **ALL** correct answers as appropriate. For open-ended questions, please provide **at least as many** responses as the question asks for.

1. RNs in Alberta are expected to practice in a manner consistent with:
 - a. *Health Professions Act (HPA) (2000; 2005; 2018)*
 - b. *CARNA Practice Standards for Regulated Members (2013)*
 - c. *CARNA Restricted Activities Standards (2019)*
 - d. *Canadian Nurses Association (CNA) Code of Ethics for Registered Nurses (2017)*
 - e. *CARNA Cervical Cancer Screening Practice Advice (2018)*

2. The responsibilities of Employers of RNs who are expected to provide Pap tests as part of their position include:
 - a. Providing adequate education time, resources, preceptorship opportunities, and facilities.
 - b. Ensuring that there is an explicit relationship with the RN taking the Pap test and a Physician or Nurse Practitioner.
 - c. Developing policies and procedures related to RN Pap testing.
 - d. Participating in ongoing monitoring of Pap test adequacy rates.
 - e. Maintaining a record of RN Pap test education.

3. The cornerstones of women-centered care include which of the following factors?
 - a. A focus on women
 - b. Involvement and participation of women
 - c. Empowerment
 - d. Respect and safety

4. Which of the following is not a risk factor for cervical cancer?
 - a. Multiple male sex partners
 - b. Early onset of first intercourse
 - c. Genital infections such as herpes simplex II (HSV2) and Chlamydia
 - d. Family history
 - e. HPV infection
 - f. Smoking

5. The Alberta Cervical Cancer Screening Program is needed because:
 - a. Organized cervical cancer screening programs reduce the rates of cervical cancer.
 - b. Having regular Pap tests may prevent a few cervical cancers.
 - c. Supporting women to have regular Pap tests can prevent almost all cervical cancers.
 - d. All clients who develop cervical cancer in Alberta have not had regular Pap tests.
 - e. More than ½ of the clients who develop cervical cancer in Alberta have not had regular Pap tests.

6. All women between the ages of 25 to 69 who have ever been sexually active should have Pap tests regularly. (Except women who have had a hysterectomy for benign reasons with no history of biopsy confirmed high-grade lesions or cervical cancer).
 - a. True
 - b. False

7. Name four high risk groups in particular whom RNs should encourage to have Pap tests regularly.
 - _____
 - _____
 - _____
 - _____

8. Women older than 69 who have never been screened for cervical cancer need 3 negative and satisfactory routine Pap tests (including a negative HPV reflex test) before screening can be discontinued.
 - a. True
 - b. False

9. Women younger than 21 who have been sexually active for 3 years need to be screened for cervical cancer.
 - a. True
 - b. False

10. Which age group is least likely to benefit from increased access to and promotion of Pap testing?
 - a. Women aged 50 to 69
 - b. Women aged 36-49
 - c. Women aged 25-35
 - d. Women under 25



11. List four reasons why an eligible woman may be reluctant to have a Pap test.

- _____
- _____
- _____
- _____

12. If a client appears apprehensive before the pelvic exam, it is best to:

- a. Reassure her and press forward.
- b. Tell her that there is nothing to worry about.
- c. Ask open-ended questions about her apprehension around the Pap test procedure.

13. List four key things that should be discussed with the client after the Pap test visit.

- _____
- _____
- _____
- _____

14. List five client groups that may have special learning, counselling, and educational needs related to cervical cancer screening.

- _____
- _____
- _____
- _____
- _____

15. Which of the following findings related to STI might be discovered during an external genital examination?

- a. Pubic lice/crabs
- b. Genital warts
- c. Genital herpes
- d. Inflammation of the Bartholin's glands



16. A client presents with the following symptoms:

- Raised painless lesions on the labia, the vestibule, and/or in the perianal region.
- Flesh-colored cluster of soft growths.

The client most likely has:

- a. Molluscum contagiosum
- b. Nabothian follicles
- c. Genital herpes
- d. Genital warts
- e. Yeast infection

17. List six abnormal findings of the ectocervix:

- _____
- _____
- _____
- _____
- _____
- _____

18. Which of the following are abnormal findings on the cervix that should be referred to a Physician or Nurse Practitioner?

- a. Friable tissue (soft, eroded)
- b. Red patchy areas
- c. Abnormal bleeding and inflammation
- d. Granular areas, white patches
- e. Pink colour

19. Name the three sampling areas of the cervix:

- _____
- _____
- _____



20. A client reports that they completed their complete set of HPV immunization vaccines and questions if they should have a Pap test. What is the correct response?
- The client does not need to have a Pap test for five years after immunization.
 - The client is immunized and no longer requires Pap tests in their lifetime.
 - The client only requires a Pap test if they are symptomatic.
 - It is very important the client still gets regular Pap test screening even if they have been vaccinated.
21. Women due for a Pap test who are pregnant or who have had a total or subtotal hysterectomy due to biopsy confirmed high-grade lesions or cervical cancer should be referred to a Physician or Nurse Practitioner.
- True
 - False
22. A smaller and narrower speculum should be used with:
- Clients who have not engaged in full vaginal penetration during sexual activity
 - Nulliparous clients
 - Circumcised clients
 - Clients whose vaginal orifices have contracted post-menopausally
23. It is acceptable to lubricate the speculum with:
- A very small amount of water soluble lubricant
 - Warm water
 - Vaseline
24. An acceptable way to insert the speculum is:
- Blade tips against the upper (anterior) wall of the vagina
 - At an oblique angle
 - With the speculum closed
 - With the speculum slightly opened
 - With the speculum angled 45° downward toward the small of the client's back
25. The best way to reposition a speculum for a client with a cervix with posterior orientation is:
- Reinsert less deeply and anteriorly, with the base of the lower blade actually compressing the anterior wall of the vagina.
 - Insert the speculum more deeply and posteriorly through compression of the perineal tissue. The blade tips will slip under the cervix into the posterior fornix.
 - Choose a plastic speculum of a larger size and reinsert as you did prior.

26. What are the ideal client conditions for cervical screening?
- Avoidance of vaginal douching for 24 hours before the test.
 - Avoidance of use of contraceptive creams or jellies for 24 hours before the test.
 - Avoidance of intercourse for 24 hours before the test.
 - Mid-cycle.
 - During menses.
27. The correct way to obtain an ectocervix specimen with spatula is:
- Rotate spatula in cervical os only 360° and end rotation so spatula is in 3 and 9 o'clock position.
 - Rotate spatula in cervical os only 180° and end rotation so spatula is in 3 and 9 o'clock position.
 - Rotate spatula in cervical os only 90° and end rotation so spatula is in 3 and 9 o'clock position.
28. The correct way to obtain a specimen with a cytobrush is:
- Insert the cytobrush gently all the way into the cervical os but no further than the end of the bristles and turn 90° to 180°.
 - Insert the cytobrush gently all the way into the cervical os but no further than the end of the bristles and turn 180° and back again.
 - Insert the cytobrush gently all the way into the cervical os but no further than the end of the bristles and turn 360°.
29. The correct way to obtain a specimen with a broom is:
- Insert the broom gently all the way into the cervical os until the lateral bristles splay out across the ectocervix and turn the broom in a clockwise circle once.
 - Insert the broom gently all the way into the cervical os until the lateral bristles splay out across the ectocervix and turn the broom in three clockwise circles.
 - Insert the broom gently all the way into the cervical os until the lateral bristles splay out across the ectocervix and turn the broom in five clockwise circles.
30. Over rotation of the endocervical brush will cause cell damage and slight capillary bleeding.
- True
 - False
31. Unsatisfactory Pap tests are mostly a result of the following:
- Cervical sampling issues
 - Specimen collection issues

32. List six key descriptions that could be documented following a Pap test visit:

- _____
- _____
- _____
- _____
- _____
- _____

33. During a Pap test visit, when does the RN seek to obtain informed verbal consent from the client?

- a. At the start of the consultation.
- b. After you have explained the external exam, speculum exam, and the Pap test procedure and before you begin.
- c. After completing the external exam, speculum exam, and the Pap test.

34. Is the RN legally responsible to protect confidentiality of client health information?

- a. Yes
- b. No

35. An informal verbal agreement between an RN and a Physician or Nurse Practitioner should be used to outline the RN's role in performing Pap tests.

- a. True
- b. False



SECTION 2: CERVICAL CANCER AND CERVICAL CANCER SCREENING

Learning Objectives

Upon completion of this Section, the learner will be able to

1. Describe the role of HPV in cervical cancer.
2. Understand cervical cancer incidence and mortality rates, natural history, and risk factors.
3. Know where to find out more information about HPV and the HPV vaccine.
4. Identify high risk groups who are underscreened/underserved.
5. Distinguish between opportunistic screening and organized population cancer screening programs.
6. List the main activities of the ACCSP.

Note: Parts of this Section (HPV and Cervical Cancer, Incidence and Mortality Rates, Natural History, Risk Factors) are adapted from the *Guideline for Screening for Cervical Cancer*.¹ Used with permission.

Natural History

Squamous cell carcinoma accounts for 80-90% of cervical malignancies and the remainder are mostly adenocarcinomas. Persistent infection with one of the carcinogenic types of Human Papillomavirus (HPV) is a necessary but not sufficient cause of both squamous and glandular malignancy.² Both types arise from a four-step progression as depicted in Figure 1:

1. HPV infection of metaplastic epithelium at the cervical transformation zone
2. HPV persistence
3. Development of pre-cancer in persistently infected cells
4. Invasive cervical cancer

HPV infection is very common in young women in their first decade of sexual activity. The lifetime cumulative prevalence of high-risk infection approaches 80%.³ More than 90% of these infections are cleared spontaneously through cell-mediated immunity within two years of infection.⁴

Persistent infection and development to pre-cancer occur in less than 10% of these infections within 5 -10 years.⁵ Regression from persistent HPV infection and from pre-cancer is also common.⁴

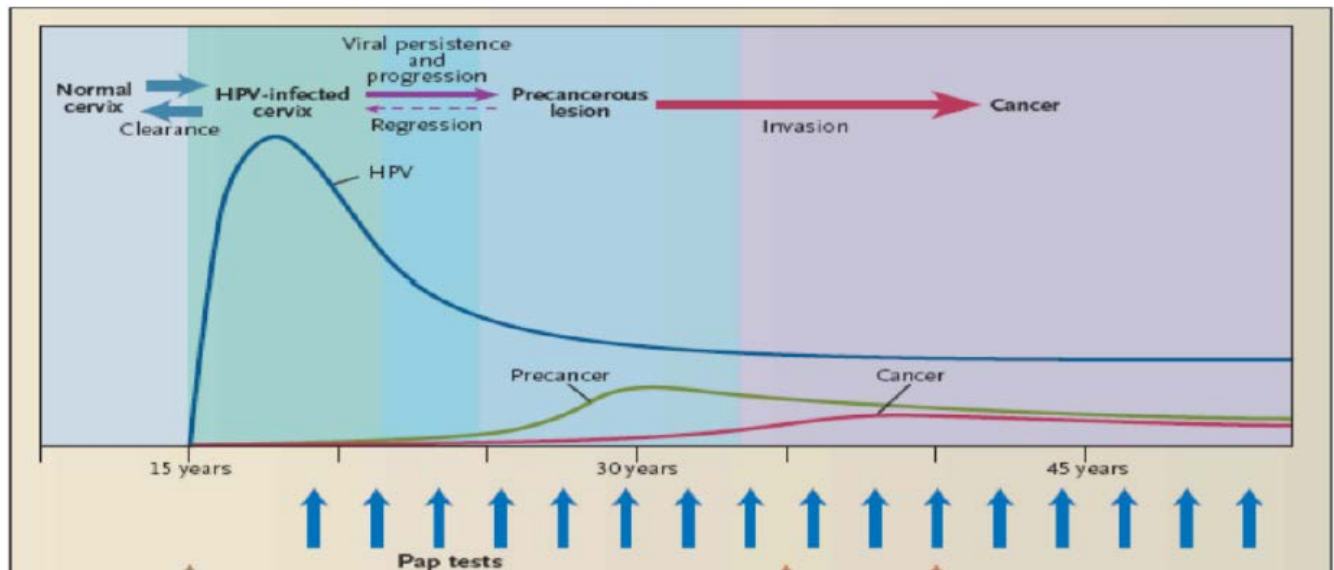

Figure 1: Four-step progression: HPV Infection, HPV Persistence, Pre-Cancer, Invasive Cancer¹

Invasive cancer arises over many years, even decades, in a minority of women with pre-cancer. Early detection and treatment during this lengthy precancerous stage can prevent the vast majority of invasive cervical cancers.

Premalignant squamous lesions are classified as either low-grade squamous intraepithelial lesions (LSIL) or high-grade squamous intraepithelial lesions (HSIL). The majority of LSIL clear spontaneously and only infrequently progress to invasive carcinoma, however approximately 13% of untreated HSIL will progress over time to invasive carcinoma.⁶

Very few cancers develop rapidly, progress to invasion, or metastasize before detection. However, the screening process is not effective for improving clinical outcomes when these rare cases occur.

HPV and Cervical Cancer

More than 45 types of human papillomavirus (HPV) are transmitted by intimate sexual contact (Bosch et al., 2008), and persistent infection with a carcinogenic type is necessary for cervical cancer to develop.² HPV is transmitted so easily that the lifetime cumulative prevalence of high-risk infection approaches 80%.⁷ Most of these infections resolve without symptoms and without treatment. A woman's immune system generally clears the virus, in which case any cervical cell changes the HPV infection may have caused resolve on their own.⁸ When the virus is not cleared, persistent carcinogenic HPV infection may cause precancerous tissue changes that can, over many years, progress to invasive cervical cancer.⁹ Early detection and treatment during this lengthy precancerous stage can prevent the vast majority of cervical cancer.

Incidence and Mortality Rates

Cancer of the cervix is now the 13th most frequently diagnosed cancer among Canadian women. An estimated 1,500 Canadian women were diagnosed with cervical cancer in 2015 and 380 women died from it.¹ The lifetime probability of a woman in Canada developing cervical cancer is now about 1 in

153,¹⁰ whereas in the absence of screening, the lifetime probability is estimated to be 1 in 28.¹¹ In Alberta, approximately 166 cases of cervical cancer were diagnosed in 2017.¹² In Canada, the mortality rate for cervical cancer decreased by 2.3% per year between 2001 and 2010¹³ and in Alberta, approximately 46 women were expected to die from cervical cancer in 2017.¹² This decline is mostly attributable to screening. Well over 1,000 lives are saved each year because of cervical screening efforts in Canada and many thousands of cases of invasive cancer are prevented.¹⁴

Although the effectiveness of regular screening for cervical cancer is undisputed, a substantial proportion of Alberta women remain underscreened. Over 30% of eligible women have not been screened at least once in the past three years.¹²

Risk Factors

The key determinants of HPV infection among women are:

- The number of sexual partners.
- The age at which sexual intercourse was initiated.
- The likelihood that her partner(s) were infected with HPV as measured by their sexual behaviour.¹⁵

Women whose partners use condoms consistently are at lower risk of acquiring HPV infection.¹⁶ However, compared with STI transmitted through genital secretions, condoms provide less protection against infections like HPV that are transmitted through contact with infected skin or mucosal surfaces. These areas are not always covered or protected by a condom.

Women who are immunosuppressed have a higher risk of HPV infection and HPV is more likely to persist. For instance, women who are HIV positive are up to 10 times more likely than at-risk HIV negative controls to be infected with HPV, with the risk increasing with declining CD4 counts.¹⁷ Even after controlling for the presence and persistence of HPV infection, women with HIV are also 4.5 times more likely to develop precancerous cervical lesions, with the risk increasing with increasing HIV-related immunodeficiency.¹⁸ Furthermore, from five years before the date of AIDS onset to five years after this date, women with HIV/AIDS are at least four times more likely to develop invasive cervical cancer compared with the general population of women.¹⁹

Women with other conditions associated with immunosuppression are also at increased risk of high-grade precancerous lesions. These conditions include systemic lupus erythematosus,²⁰ inflammatory bowel disease,²¹ and transplantation.²²

Diethylstilbestrol (DES) was given to some pregnant women between 1940 and 1971 to prevent miscarriage. Women whose mothers took DES when pregnant with them have a 1 in 1,000 risk of developing clear-cell adenocarcinoma of the vagina or cervix.

Among women with persistent HPV infection:

- The most important risk factor for cervical cancer is inadequate cervical screening.
- Smoking independently increases the risk of cervical cancer by at least two-fold as does high parity.¹⁵



Rapid Progression of Cervical Cancer

Occasionally cervical lesions appears to have progressed more rapidly in some women. This may be due to:

- Inadequate specimen collection and preparation*, and/or
- Lab misinterpretation.

*Rationale for why it is important to learn proper Pap testing techniques.

Having regular Pap tests can prevent almost all cervical cancers by finding cell changes early enough to be treated effectively.

Half of the women who develop cervical cancer in Alberta have not had regular Pap tests.

HPV and HPV Vaccine

Certain types of HPV cause genital warts, cervical cancer and other cancers of the mouth, throat, anus, vulva, vagina and penis.

In Canada, the following immunizing agents are in use:

Vaccine Name	HPV Types Covered	Offers Protection Against
Cervarix™ (bivalent human papillomavirus) Sometimes referred to as the HPV2 vaccine.	HPV types 16 and 18	Over 70% of cervical cancers
Gardasil® (quadrivalent human papillomavirus) Sometimes referred to as the HPV4 vaccine.	HPV types 6, 11, 16 and 18	Over 70% of cervical cancers and 90% of genital warts.
Gardasil®9 (nine-valent human papillomavirus) Sometimes referred to as the HPV9 vaccine.	HPV types 6, 11, 16, 18, 31, 33, 45, 52 and 58	Over 90% of cervical cancers and 90% of genital warts.

Table 1: Updated Recommendations on Human Papillomavirus (HPV) Vaccines²³

According to the National Advisory Committee on Immunization (NACI) guidelines:²⁴

- HPV vaccine should be offered to females and males before they become sexually active to ensure maximum benefit. **The primary age group recommended is 9 to 14 years.**
- Females aged 9 to 26 years **should be** offered the HPV vaccine (Cervarix™, Gardasil® or Gardasil®9).
- Females over the age of 26 years **may be** offered the HPV vaccine (Cervarix™, Gardasil® or Gardasil®9) if they have not been previously vaccinated or have not completed the series of vaccinations*.
- Males aged 9 to 26 years **should be** offered the HPV vaccine (Gardasil® or Gardasil®9).



- Males over the age of 26 years **may be** offered the HPV vaccine (Gardasil® or Gardasil®9) if they have not been previously vaccinated or have not completed the series of vaccinations*.
- At this time, the HPV vaccination is not recommended for pregnant women or females and males under nine years of age.

*Women and men over the age of 26 should consult their Physician about their need for the HPV vaccine. **Even if women are vaccinated against HPV, they still need regular Pap tests.**

Vaccination schedules vary depending on age, sex, immunocompetence and type of vaccine. Please familiarize yourself with the HPV vaccines that are available in your area.

Together, Pap test screening and HPV vaccination offer effective protection against cervical cancer. Alberta Health Services, in partnership with Alberta Health, offers the HPV vaccine free of charge to all girls and boys in grade 6. The HPV vaccine is offered to girls and boys in grades 7-9 if they did not receive the vaccine in grade 6. The vaccine is available for free for girls and boys up until the end of grade 12.

High Risk Groups

There are groups of women who are less likely to be screened for cervical cancer. Therefore it is valuable to focus on increasing screening engagement and retention rates in these populations including:

- Older women
- Women living in poverty
- Immigrant women
- Indigenous women
- Rural women
- Women who have poor access to Pap test providers

Opportunistic Versus Organized Population-Based Cancer Screening

The delivery of cervical cancer screening may be opportunistic or organized:

- **Opportunistic screening** depends entirely on the initiatives of individual clients and/or Physicians/Healthcare Providers and does not achieve optimal screening coverage of the eligible population.
- **Organized population-based screening programs** allow for a standardized approach to screening, follow-up, and treatment. A population-based screening program is an organized, integrated process where a test is offered systematically to all individuals in the defined target population, and all activities along the screening pathway are planned, coordinated, monitored and evaluated through a quality improvement framework.²⁵

An organized cervical cancer screening program requires a registration database of eligible women. The database of an organized screening program enhances recruitment by identifying those women who have never been screened and facilitate the recall of women overdue for routine screening and those who have not had appropriate follow-up of an abnormal test.

Using regular Pap tests to find abnormal cell changes at an early stage before there are any symptoms can prevent almost all cancers of the cervix. All abnormal bleeding should be assessed and evaluated by a Physician or Nurse Practitioner.

“Remember, one of the early signs of cervical cancer is unexplained abnormal bleeding. If a client continually puts off her exam because of irregular bleeding, it may delay diagnosis of cervical cancer.”²⁶

The Alberta Cervical Cancer Screening Program Overview

The ACCSP is a provincial organized population-based screening program coordinated by Alberta Health Services in partnership with healthcare providers. The goal of the ACCSP is to reduce the incidence and mortality of cervical cancer through early detection and treatment of precursor conditions. The purpose of the ACCSP is to enhance and strengthen the cervical screening services already available to Alberta women aged 25-69 years.

The ACCSP coordinates a number of activities including, but not limited to:

- Providing a correspondence system that includes invitations, results, recalls, and follow-up letters for clients and healthcare providers
- Promoting and increasing access to cervical cancer screening services in the province
- Working with healthcare providers and labs to contact women who have been screened
- Educating women and healthcare providers
- Providing cervical cancer screening quality assurance

The ACCSP result letters are sent to women across Alberta after their Pap tests. Normal result letters are sent immediately whereas abnormal result letters are sent following a three-week delay. Follow-up reminders are sent to healthcare providers and women regarding overdue follow-up tests. Research from around the world shows that organized cervical cancer screening programs like the ACCSP reduce the rates of cervical cancer.

Resources for the public can be downloaded and printed from: https://screeningforlife.ca/order-resources/?type_of_screening='Cervical'

Pre-printed resources can also be ordered at no charge from: https://screeningforlife.ca/order-resources/?type_of_screening='Cervical' and then clicking “order online” or by calling toll free 1.866.727.3926.

Review the other information and forms available for healthcare providers here: <https://screeningforlife.ca/for-health-providers/cervical-screening-information/>.

Here is an example of an **invitation letter** that a client may receive:



Alberta Health Services

Alberta Cervical Cancer Screening Program

MONTH DD, YEAR

FIRSTNAME M. LASTNAME
1-234 56 AVE SW
BROCKET, ALBERTA T1T1Y1

Dear first name, last name

Important Health Notice – Request to Participate in Cervical Cancer Screening

I am writing on behalf of the Alberta Cervical Cancer Screening Program (ACCSP) to ask you to participate in cervical cancer screening. Screening for cervical cancer with a Pap test can prevent up to 90% of cervical cancer. A Pap test removes a small sample of cells from the cervix and is done at your healthcare provider's office.

Who should have a Pap test?

In Alberta, all women between 25 and 69 years of age who have been sexually active can have cervical cancer screening with a Pap test, free of cost. You should have a Pap test every three years, even if you have had the human papillomavirus (HPV) vaccine.

Why are Pap tests important?

Regular Pap tests save lives by finding changes to cells of the cervix. When these changes are found early and treated, they won't become cancer. But if these changes aren't found and left untreated, they could develop into cancer. You can find more information about cervical cancer screening in the brochure that we have included.

Where can I have a Pap test?

Book your Pap test appointment with your regular healthcare provider. The test is done in a healthcare provider's office or clinic.

If you need help finding a family doctor or a clinic in your area, please see the back of this letter or visit <http://screeningforlife.ca/book-a-screening/>.

Where can I learn more?

To learn more about cervical screening, prevention, and privacy, please see the back of this letter. For more information, go to screeningforlife.ca or call us at **1-888-727-3926**. The ACCSP will send you the results of your Pap test and let you know when you are overdue for your next Pap test.

Screening for Life – have a Pap test every 3 years!

Sincerely,

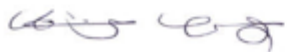

Dr. Huiming Yang
Medical Director, Screening Programs
Alberta Health Services



Alberta Cancer Screening Report

If the client is unaware of their previous screening history you can refer to Netcare and check their screening status (see below). For more information, visit <https://screeningforlife.ca/for-health-providers/cancer-screening-status-reports/>.



Cancer Screening Information at Your Fingertips FACT SHEET

Cancer screening information in one complete report in Alberta Netcare

A new Cancer Screening Status Report is now available within the Alberta Netcare Portal. This easy to access report indicates at a glance if a female patient is due for breast, cervical and colorectal cancer screening or follow-up, and if a male patient is due for colorectal cancer screening or follow-up.

Netcare users will be able to view their patients' cancer screening status in a single report. This report is a new clinical decision support tool, intended to assist healthcare providers in determining what, if any, action needs to be taken to get their patients up to date on cancer screening, in accordance with the Alberta Clinical Practice Guidelines.

Placing actionable cancer screening status at the fingertips of health providers puts Alberta's health system at the forefront of cancer screening support in Canada.



Alberta Cancer Screening Programs

Screening Status for Breast, Cervical and Colorectal Cancer

(Report Date: 07-Mar-2017)

SMITH, Sally Mary	Age: 54 years Date of Birth: 21-Mar-1963 Gender: Female Alberta Unique Lifetime Identifier: 123456789
--------------------------	--

Type	Last Screen Type	Date of Last Exam*	Result of Last Exam	Status	Qualifier
Breast	Mammogram	20-May-2012	Normal	Due for screening	As per recommendation of last exam
Cervical	Screening Pap Test	01-May-2012	Abnormal	Follow-up as clinically indicated	Due for repeat Pap or referral as appropriate. Please refer to Alberta TOP Clinical Practice Guidelines to determine treatment status of patient.
Colorectal	FIT	03-Jun-2016	Normal	Up-to-date	FIT every 1-2 years

Cervical Cancer Screening: Women with a history of hysterectomy may appear on this report.

Colorectal Cancer Screening: At the current time, the Alberta Colorectal Cancer Screening Program does not capture information about screening colonoscopy or diagnostic follow up. The status in this report is based solely on the availability of FIT or FOBT test results, and a 2-year screening interval with FIT.

This report tracks patients active in the Alberta Cancer Screening Program (CSP) with the exception of a diagnosis of one of the above types of cancer, out of province and/or exempt. The status contained in this report does not replace clinical assessment and judgment based on individual history and the Alberta TOP Clinical Practice Guidelines (for a link to the guidelines, please refer to the Resources section of Netcare).

*Newer screening exams may be available in other areas of Netcare due to a delay in data sent to the CSP.

Guideline for routine screening: Breast – Women 50-74 years, screening mammography every 2 years; Cervical – Women 25-69 years, Pap every 3 years; Colorectal – all genders 50-74 years, FIT every 1-2 years.



Screening Participation

Participation rate is a key programmatic indicator; it represents the percentage of women 25 to 69 years who have had at least one Pap test in a three-year period. Alberta’s target for the cervical cancer screening participation rate is 80%.

According to the Canadian Community Health Survey, which collects self-reported information, in 2015-2016, 80.1% of eligible women in Alberta reported having at least one Pap test in the past three years.²⁷ However, Figure 2 shows that in Alberta the participation rate for women 25-69 across AHS zones ranged from 57.4% to 67.0% during 2016-2018, while the provincial participation rate was reported as 64.3%. Through collaboration with AHS zone leaders, healthcare providers, and stakeholders the ACCSP continuously seeks to further engage its target population as it strives toward Alberta’s target of 80% for cervical cancer screening participation.

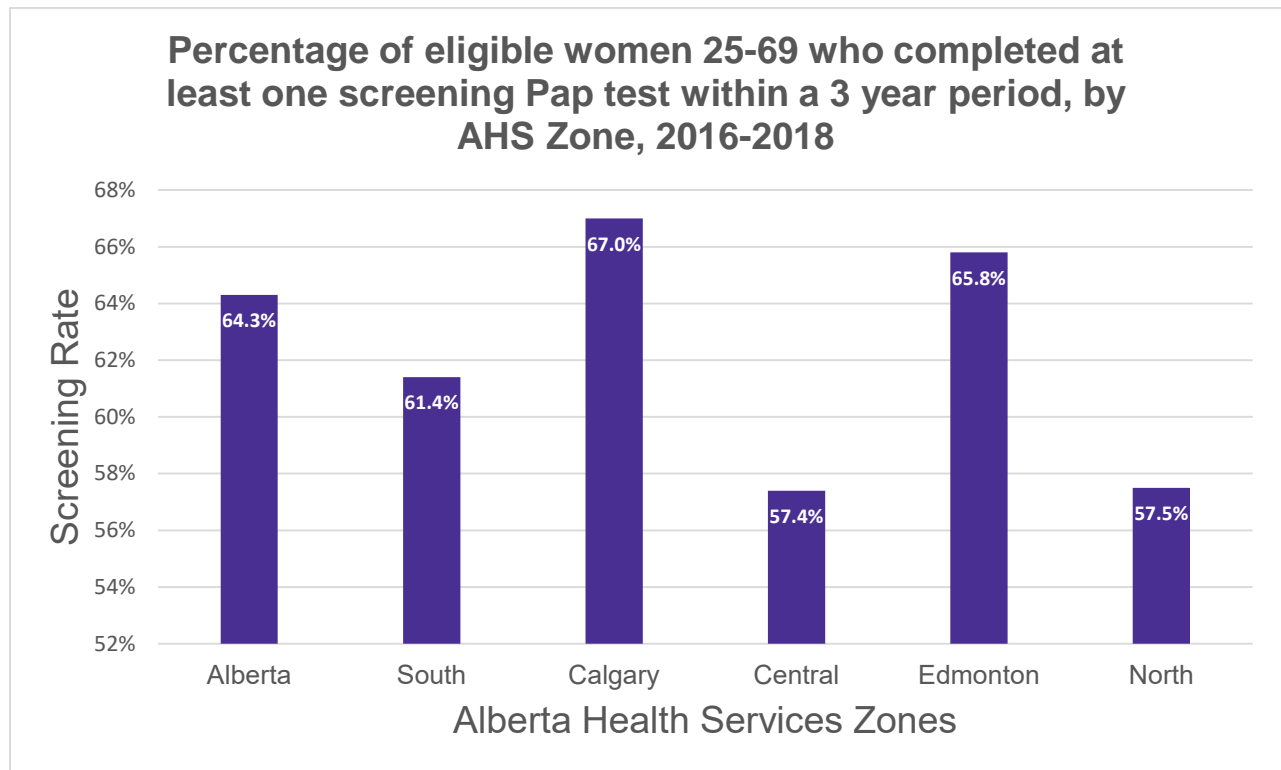

Figure 2: Percentage of eligible Albertans aged 25-69, who completed at least one screening Pap test within a three year period, by AHS Zone, 2016-2018²⁸

Recommended Readings

1. Guideline for Screening for Cervical Cancer
<https://top.albertadoctors.org/CPGs/Lists/CPGDocumentList/Cervical-Cancer-Screening-CPG.pdf>
2. Cervical Cancer Frequently Asked Questions
<https://top.albertadoctors.org/CPGs/Lists/CPGDocumentList/Frequently%20Asked%20Questions%20May%202016.pdf>
3. Human Papillomavirus Vaccine (HPV-9)
<https://www.albertahealthservices.ca/assets/info/hp/cdc/lf-hp-cdc-hpv-info-sht-07-240-r01.pdf>
4. HPV Frequently Asked Questions <https://www.hpvinfos.ca/frequently-asked-questions/>

The following recommended readings provide additional information on cervical cancer, HPV, other precursors and natural history of the disease:

5. Schiffman, M., Castle, P. E., Jeronimo, J., Rodriguez, A.C., & Wacholder, S. (2007). Human papillomavirus and cervical cancer. *Lancet*, 8(370)(9590), 890-907.

Section 2: Self-Test

1. What causes cervical cancer?

2. Describe cervical cancer

a. Incidence in Alberta

b. Natural history

c. Risk factors (at least 3)

3. Where could you find more information on HPV and the HPV vaccine? (2 sources)

4. What are three important high risk groups for RNs to target for Pap testing?

5. What is the difference between opportunistic and organized cancer screening?

6. What are four activities of the ACCSP?

SECTION 3: CERVICAL SCREENING CYCLE

Learning Objectives

Upon completion of this Section, the learner will be able to

1. Describe when and why to initiate cervical cancer screening.
2. List the risks of over screening.
3. Identify who should have cervical cancer screening and how frequently.
4. Identify clients who should be excluded from cervical cancer screening and those who should have increased surveillance.

Note: Parts of this Section (Initiating Cervical Cancer Screening, Screening Interval, Increased Surveillance and Discontinuing Screening) are adapted from the Guideline for Screening for Cervical Cancer.¹ Used with permission.

Initiating Cervical Cancer Screening

The current Alberta *Guideline for Screening for Cervical Cancer*¹ recommends that cervical cancer screening begin three years after onset of sexual activity or at 25 years, whichever occurs later. Sexual activity is defined as any skin-to-skin contact in the genital area including touching, oral sex, or intercourse with a partner of any sex or gender.

Cervical cancer is rare in Alberta among females younger than 21 years (see Figure 3). In 2009, only one case occurred in this age group (0.7 per 100,000).²⁹ High screening coverage in Alberta likely does not account for this low rate – a comparably low rate is observed in this age group in Europe, where most countries do not target women for screening before age 25.⁷ Invasive cervical cancer is rare among younger women because progression from HPV infection to precancer typically takes 5 to 10 years, and development of invasive cancer takes years longer.⁹

Approximately 50% of women will acquire an HPV infection within four years of sexual debut.³⁰ Screening females who have become sexually active only recently tends to detect transient manifestations of recently acquired HPV infection that are likely to regress spontaneously. Among 13 to 22 year old women with LSIL, 93% will regress spontaneously while only 3% will progress to HSIL within three years.³¹ Among women younger than age 25 with histologically confirmed CIN 2 or 3, more than half of the lesions will regress without treatment by age 25, while the estimated rate of progression to invasive cancer from CIN 3 is roughly 0.3% per year in this age group.³²

Women Younger than 21 Years and Aged 21-24

The 2016 TOP Cervical Cancer Screening clinical practice guideline (CPG) recommended the initiation of screening rise from age 21 to age 25 or 3 years after becoming sexually active, whichever occurs later. The guideline indicates that women under the age of 21 should not be screened, while screening for women aged 21-24 is optional. The number of women aged 18-20 getting screened is decreasing every year, where only 13.7% of women in this age group

were screened in 2016-2018.²⁸ Screening in this age group is not appropriate as the benefit is very minimal.

If Pap tests are performed on women under 21 and LSIL identified, there is a very high probability these changes will resolve spontaneously. For this reason, recommended follow-up of women younger than 21 years with ASC-US or LSIL is more conservative than for older women. HPV DNA testing results can also be misleading for women with ASC-US or LSIL under age 30. Because HPV is so frequent in this age group, HPV testing would result in high rates of colposcopy referrals with a very low probability of pre-cancerous lesion or invasive cervical cancer yet a tendency for overtreatment. Therefore, Pap testing and HPV testing for women under the age of 21 is strongly discouraged.

For women over 21, analysis of national mortality and incidence data show that mortality has dropped substantially in older age groups, but it was always low below the age of 30. Current incidence and mortality rates are similar to data in 1972 to 1976 prior to widespread screening. In Alberta from 1994-2013, the annual incidence rate for cervical cancer was extremely low at age 20 or younger, and remained low to age 25 (see Figure 3). There is a clear increase in incidence after 25 years of age.

Delaying routine screening invitations to age 25 is unlikely to miss invasive disease resulting from dysplasia arising in the teenage years. In fact, a case-control study in the United Kingdom suggests that screening women aged 20 to 24 has little or no impact on the incidence of cervical cancer.³² However, many women aged 21-24 in Alberta continue to be screened – including in 2016 -2018 about 53.3% of women in this age group.²⁸

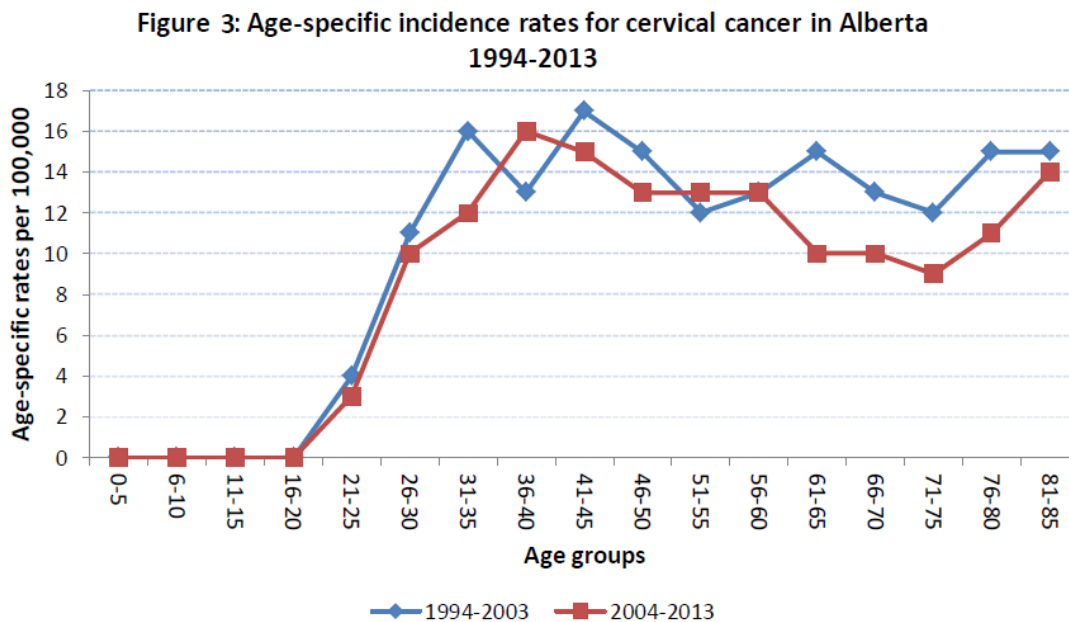

Figure 3: Age-specific incidence rates for cervical cancer in Alberta 1994-2013¹

Women 25-29

There is still uncertainty about the effectiveness of screening for these rare cervical cancers in women under 30 years old. The National Health Services (NHS) cervical cancer screening program in the United Kingdom (UK) investigated this concern and found that the effectiveness of screening improved with age, with odds ratios around 1 (no effect) in women under 25, around 0.5 by age 30, and 0.2 around age 50. Further, they also showed that there was no protective effect against developing cervical cancer in the future from screening below the age of 25. This was supported by data from elsewhere. The UK modified its cervical screening policy to initiate screening at age 25 in 2003, while programs in the Netherlands and Finland start at age 30.

Thus current evidence regarding screening initiation for women 25 years of age shows very low risk but not absence, therefore the small potential benefits of screening must be balanced against the potential harms. The CTFPHC concluded that the balance of benefit against harm changes in the middle of the decade. Clinicians can offer women a choice to be screened and/or may suggest screening to women who may be at a higher risk and more likely to benefit e.g., early sexual debut, multiple partners (or whose partners have had multiple partners), or not HPV vaccinated.

Screening Interval

The evidence for screening intervals comes from case control studies in several countries showing that there was a small increase in sensitivity between five and three-year intervals but the gain from shorter intervals was minimal. All provincial programs in Canada have recommended three years as a reasonable balance between benefits and harms. Remembering a three-year interval for getting a Pap test may be difficult for women and their providers, therefore the ACCSP provides province-wide reminder notifications to women after three years that they are due for a Pap test.

When to Discontinue Screening

Different jurisdictions have different approaches as to when screening should be discontinued; ranging from 60 to 65, or up to 70 years of age. Many guidelines are based on the assumption that the death rate drops in older women. However, in Canada, current mortality rates rise steadily with age.

Cervical cancer often occurs among older women who have never been screened or have not been regularly screened. In addition, it can occur in women who have had abnormalities treated earlier in life that recur in old age.

Based on life expectancy, and provided women 69 years of age and older have had three normal results from screening over the previous 10 years with no other related health problems, screening for cervical cancer can be discontinued. However, the decision to discontinue screening should be a personal one. Women who have a long life expectancy, no other health issues and are aware of the challenges associated with Pap testing in older ages (e.g.,

estrogen depletion/need for replacement, discomfort/pain, difficulty obtaining sample, false-positive tests) may wish to continue with screening.

Balancing Risks and Benefits

The benefits of screening to reduce the incidence of invasive disease and death due to cervical cancer have been consistently shown in cohort and case-control studies. Most advanced cervical cancer (with consequent mortality) occurs among women who have not undergone screening or who have had a long interval between Pap tests. Conversely initiating screening when the risk is very low and/or screening too frequently can produce more harm than benefit.

Such harms may include:

1. Inconvenience, discomfort and embarrassment that women feel from attending for Pap tests, and having uncomfortable bimanual examinations.
2. Physical and psychological impact of being informed about an abnormal test, and according to the abnormality, being asked to undergo repeat testing, referral for colposcopy, biopsy and return for results, or having treatment with LEEP or other procedure.
3. The risk for pregnancy loss for those women who had a LEEP or cone biopsy rises from 0.6% to 1.8% (increase of 1.2%) primarily in the second trimester.

Younger women have more abnormal results but these results are often transient and much less likely to represent a serious abnormality, putting these young women at risk of over diagnosis and overtreatment (see Table 1). When younger women are referred, the Colposcopist may biopsy the cervix. If the biopsy shows cervical intra-epithelial neoplasia, the cervix may be treated by removing the transformation zone using various methods. These procedures cause short-term pain, bleeding and discharge but could lead to early loss of future pregnancies or premature labour. This risk is more serious in younger women who are less likely to have started or completed their families, and many can be considered “overtreatment” since few of these lesions would progress to cancer. Although at the time of the procedure, it is not possible to know which ones will progress and those that are indolent. Colposcopists have become more cautious in recent years so there are fewer large excisions.



Alberta Cervical Cancer Screening Program Colposcopy Referrals by Age Group			
Age group (years)	Number screened	Number referred to colposcopy	% referred to colposcopy
18 - 20	24,985	497	2.0%
21 - 29	194,499	10,655	5.5%
30 - 39	210,833	7,671	3.6%
40 - 49	173,359	3,624	2.1%
50 - 59	154,986	2,412	1.6%
60 - 69	80,344	806	1.0%
≥ 70	13,705	166	1.2%
Total	852,711	25,831	3.0%

Table 2: Colposcopy Referrals by Age Group in the ACCSP 2008-2013¹

Each woman's values, preferences and beliefs about cervical screening must be taken into consideration when presenting the information about possible benefits and harms from the screening process. Screening should always be a choice and an informed decision made by the woman.

Limitations of Screening

Like all screening tests, Pap tests are not perfect. A single negative Pap test result does not rule out cervical pre-cancer or cancer. Women need to be screened regularly.¹

A **false-negative screening test result** occurs when the Pap test fails to detect an abnormality that is present on the cervix. False-negative results arise because either:

- The abnormal cells were not collected due to limitations of cervical sampling and specimen preparation
- OR because abnormal cells were not identified by the laboratory.

The sensitivity of conventional cytology to detect high-grade lesions varies widely in published studies between 30% and 87%³³ and LBC does not appear to increase sensitivity substantially, although it does reduce the rate of unsatisfactory samples.³⁴ Repeat screening at regular intervals increases the sensitivity of cervical screening and is necessary to provide adequate lifetime protection from cervical cancer. The Pap test has been so successful at reducing cervical cancer incidence because the sensitivity increases in the context of regular use.

To help overcome the false sense of security that can arise from a false-negative test result, it is important to advise women to report unusual vaginal bleeding or discharge including bleeding after intercourse, after menopause, or between menstrual periods.

False-positive screening test results are also of concern. Given the transient nature of many cervical changes, screening detects many abnormalities that are destined to resolve on their

own. The 2016 TOP guideline is intended to minimize the anxiety and harms associated with screening while helping to assure that clinically significant cervical changes are identified.

Increased Surveillance

While the 3 year screening interval is safe for most women with negative screening histories, some women should continue to screen annually.

Women who need annual Pap tests include those who are immunosuppressed because these women have of an increased likelihood of HPV infection, precancerous lesions, and invasive cervical cancer. Another group that should undergo annual screening indefinitely includes women who have ever had biopsy confirmed high-grade squamous intraepithelial lesions (HSIL), adenocarcinoma in situ (AIS), or invasive cervical cancer (See Table 3). Despite undergoing treatment, these women have more than twice the risk of invasive cervical cancer compared with the general female population for 25 years or more.^{35, 36} If they have undergone hysterectomy, these women should have vault smears every year.³⁷

For women who have ever had:	Surveillance Recommendations
<ul style="list-style-type: none"> • Biopsy confirmed high-grade squamous intra epithelial lesions (HSIL) • Adenocarcinoma in situ (AIS) • Invasive cervical cancer 	<ul style="list-style-type: none"> ✓ Suggest annual screening with Pap for life.^{**}
<ul style="list-style-type: none"> • Total hysterectomy with previous HSIL, AIS or invasive cervical cancer 	<ul style="list-style-type: none"> ✓ Suggest annual vault smears for life.^{**}
For women who have been sexually active with immunosuppression from:	
<ul style="list-style-type: none"> • Human immunodeficiency virus (HIV/AIDS) • Lymphoproliferative disorders • Organ transplantation • Use of long-term oral corticosteroids. • Common/long term use of immunosuppressant, tumor necrosis factor inhibitors 	<ul style="list-style-type: none"> ? Evidence is limited/non-existent regarding need for increased frequency (i.e., annual) screening in this cohort of women. ✓ Some women may benefit from annual surveillance. ✓ Assess on case-by-case basis. ✓ Use clinical judgement.
<p>[*]Provide the history to the lab with the specimen. ^{**}Based on expert opinion/consensus. Consider patient choice.</p>	

Table 3: Increased Risk Surveillance¹

Discontinuing Screening

High-grade abnormalities and cervical cancer is exceedingly rare among older women with adequate screening histories.³⁸ Cervical cancer among older women occurs almost entirely among those who are unscreened or underscreened. Screening these women can reduce morbidity and mortality. Obtaining satisfactory samples from older women can be challenging because of conditions such as atrophy and cervical stenosis (see [Section 7: Physiology, Anatomy & Abnormal Findings](#); [Section 8: External & Speculum Exam](#)).



Although the exact age to discontinue screening is somewhat arbitrary, after the age of 69 the potential harms of on-going Pap testing in well-screened women who are not otherwise at high risk may well outweigh the benefits. Since cervical cancer is so unlikely in these women, the potential benefits are minimal.

Women with an intact cervix can generally cease screening after age 69 if they have had at least three consecutive satisfactory and negative Pap tests in the last 10 years.

Women who are immunocompromised and those who have a history of biopsy confirmed high-grade lesions or cervical cancer should continue with annual screening.

Who Should Have a Pap Test and How Frequently?

Age Range	21-24	25-29	30-69	≥70
Screen	? Optional screening	✓ Initiate routine screening	✓ Routine screening	✓ Screen If unscreened/under-screened (i.e., not screened regularly at three year intervals)
Interval	Every three years	Every three years	Every three years	Until three consecutive negative Pap tests (collected at least one year apart) within 10 years
Evidence	Harm is likely greater than benefit (moderate evidence)	Benefit is likely greater than harm (moderate evidence)	Benefit is likely greater than harm (strong evidence)	Less evidence, but biologically plausible that the risk of disease is high/continues. Screening may reduce morbidity and mortality.

Table 4: Cervical Cancer Screening Algorithm¹

Exclusions from Pap Testing

The following women may be excluded from Pap testing:

- Women who have never engaged in sexual activity (not just sexual intercourse, but digital or oral sexual activity with a partner of any gender).
- Women who initiated intimate sexual activity less than 3 years ago.
- Women who have had a total hysterectomy for benign disease, with complete removal of the cervix and no history of biopsy confirmed high-grade lesions or cervical cancer
- Women > 69 years old with a cervix, provided there have been at least 3 consecutive negative results within the last 10 years, there is no history of cervical malignancy or high-grade lesions and she is not immunosuppressed.
- Women < 21 years old. The risk of cervical cancer is rare in women younger than 21 years. This is because it takes many years for cervical cell changes to develop into cancer, beginning with a persistent high-risk HPV infection.





Women who meet the exclusion criteria should be reported to the ACCSP as ineligible for screening using the following ineligibility form:

Healthcare Provider's Report of Ineligibility for Cervical Cancer Screening: <https://screeningforlife.ca/wpcontent/uploads/2019/12/ACCSP-Healthcare-Provider-Report-of-Ineligibility-for-Cervical-Screening-Oct-2017.pdf>

The *Guideline for Cervical Cancer Screening*¹ does not recommend routine screening for the “excluded” women noted above. However, screening of these “excluded” women **may** be undertaken based on professional judgement.

Other provinces and countries have different policies and may have different screening intervals or start screening at different ages. This may be confusing for women coming to Alberta and needs to be clarified with clients who are new to Alberta.

Recommended Readings

1. *Guideline for Screening for Cervical Cancer:*¹
<https://top.albertadoctors.org/CPGs/Lists/CPGDocumentList/Cervical-Cancer-Screening-CPG.pdf>

<p>These recommendations pertain to asymptomatic women. If the woman is symptomatic she should be investigated regardless of age. See: 'Abnormal Uterine Bleeding in Pre-Menopausal Women' at: https://sogc.org/clinical-practice-guidelines.html.</p>	
Initiate Screening	<p>Cervical cancer screening applies to women including transgender people with a cervix who are or have ever been sexually active. (Sexual activity includes intercourse as well as digital or oral sexual activity involving the genital area with a partner of any gender.)</p> <ul style="list-style-type: none"> ✓ Do initiate screening three years after the first sexual activity or at age 25, whichever is later. ✓ Optional screening for ages 21-24 based on informed patient choice and/or where women may benefit, i.e., those at higher risk. (See FAQ for patient discussion points.) X DO NOT screen under age 21.
Screening Interval	<ul style="list-style-type: none"> ✓ Every three years from initiation or the time of the last normal Pap test result
Discontinue Screening	<ul style="list-style-type: none"> ✓ Stop screening women at 70 years old and older who have had at least three consecutive normal Pap tests at any interval. ✓ Initiate or continue screening women age 70 years old and older who have never been screened or under-screened with three annual Pap tests. If all three results are normal, screening can be discontinued. ✓ Women may choose to continue screening beyond age 70 provided they have a long life expectancy, can benefit from continued screening, and understand the possible risks and difficulties associated with screening at this age.
Increase Surveillance	<p>Some women may require surveillance because of increased risk or past cervical disease however, the evidence is not conclusive at this time and therefore based on expert opinion and experience.</p> <p>Consider screening the following women annually for life with:</p> <ul style="list-style-type: none"> • A biopsy-confirmed high-grade squamous intraepithelial lesions (HSIL), adenocarcinoma in situ (AIS), or invasive cervical cancer. (For women having had a hysterectomy for invasive cervical cancer, perform a vault smear annually thereafter for life.) • Severe autoimmune disorders (e.g., HIV/AIDs) and/or those taking long term oral immunosuppressant medications may require more frequent screening, i.e., annually.
Screening in Other Circumstances	
<p>Pregnancy → continue screening only if due for screening.</p> <p>If ASC-US or LSIL is detected during pregnancy, do not repeat the Pap test until six months post-partum. All other findings, especially more advanced lesions, should be managed according to Management of Abnormal PapTest Result.</p>	
<p>Hysterectomy with cervix removal for BENIGN DISEASE → discontinue screening.</p> <p>Subtotal hysterectomy and retained cervix → continue screening as per guidelines.</p>	
<p>HPV vaccinated → continue screening. The HPV vaccine should be recommended to eligible unimmunized women according to NACI guidelines: http://www.albertahealthservices.ca/assets/info/hp/cdc/if-hp-cdc-hpv-bio-pg-07-240.pdf and http://www.albertahealthservices.ca/services.asp?pid=service&rid=1026220.</p>	

Table 5: Summary of the Cervical Cancer Screening Clinical Practice Guideline¹ ([download](#))

Section 3: Self-Test

1. What are 3 reasons the recommended age of cervical screening initiation was increased?
2. List who should participate in cervical cancer screening and how frequently?
3. What is the screening process for women who have had a hysterectomy?
4. Who should be excluded from cervical cancer screening and what are some special circumstances to note?
5. Who should be on increased surveillance?

SECTION 4: COUNSELLING AND EDUCATION

Learning Objectives

Upon completion of this Section, the learner will be able to:

1. Describe reasons why an eligible client may not want to obtain a Pap test.
2. Describe counselling and education strategies that are important to consider before, during, and after a Pap test.

This Section is adapted from SIAST, 2000, p.2-4. Used with permission.

Women have different reactions to having a pelvic examination. Some are quite calm and relaxed, while others are extremely apprehensive, embarrassed, or fearful and find the examination very uncomfortable. A client's past experiences with pelvic exams, her comfort with her own body, and her sexuality all interrelate to determine her level of anxiety during a pelvic exam.

Reasons Why Women May Avoid Pap Tests

There are many reasons why an eligible woman may not want to obtain a Pap test including:

- Lack of information and understanding of Pap test
- Fear of the test
- Fear of cancer
- Fear of pain
- Embarrassment
- Modesty
- Religious and social factors
- Language barriers including written and verbal
- Difficulty in communicating with healthcare providers
- Lack of childcare facilities
- Accessibility issues (e.g. transportation, parking, transit, access to the building)
- Other peoples' attitudes regarding the Pap test (e.g., husband, family, religious leaders)

To make the pelvic examination a positive experience for each woman, it is important that the RN performing the pelvic examination talk to the client before, during, and after the pelvic exam.

The RN needs to have a non-judgmental, gentle, sensitive, and caring attitude and create an atmosphere of trust, privacy, and respect. Communication is the key and a good RN-client relationship will promote client relaxation, reduce anxiety, enhance learning, and decrease client discomfort.

Before the Exam

Introduce yourself to the client before they undress for the exam. Meeting the client before the exam when they are dressed and sitting, as opposed to lying in the lithotomy position in a gown, helps the client feel less vulnerable and more in control of the situation. If this is not possible, ask the client to undress, change into the gown, and be sitting on the exam table for initial discussion before the exam.

Use open ended questions to assess the client’s learning needs. For example, “What have your friends told you about pelvic exams and Pap tests?” “How did you feel during your previous pelvic exams?”

Explore sexual and reproductive issues. For example, “What is your chosen method of contraception?” “Has you ever experienced any pain or discomfort with sexual activity, now or in the past?”

Listening is important. Focus on the client’s feelings, fears, and concerns and dispel any myths. Never talk down to a client or take her concerns lightly.

Explain in simple and concise lay terms the following:

- Purpose of exam.
- The role of HPV reflex testing. Give her a copy of the handout “HPV Testing: Information for Women Having Pap Tests” that are provided in the trays of liquid-based supplies. (See [Section 10: Pap Test Results](#) for more information about HPV testing, and see <https://screeningforlife.ca/wp-content/uploads/2019/12/ACCSP-Reflex-HPV-Info-for-Physicians-2016.pdf> for a copy of the handout).
- Procedure (external, speculum exam, and Pap test).
- Female anatomy.
- Optional positions for the exam (e.g. m-shaped position, knee-chest position – see [Section 8: External & Speculum Exam](#) for a brief explanation of each position).
- Instruments used in exam.
- Length of procedure and sensations (pressure, mild cramps not pain) experienced during the pelvic exam.
- There may be some minor painless spotting a day or two following the Pap test.
- The process for the sample after it is sent to the lab.

Tell the client that you will tell her what you are going to do before you do it, and that if she feels any pain or anxiety at any time during the pelvic exam that you will stop what you are doing until she feels more comfortable.

Use language that is consistent with the client’s developmental age and educational level, e.g. use the word sex instead of intercourse when deemed appropriate for the adolescent client.

Visual aids work well. Show the client a speculum and how it will be inserted into her vagina to visualize the cervix and a spatula and cytobrush, or broom. Ensure the client has written

information on Pap tests. See available ACCSP brochures at https://screeningforlife.ca/order-resources/?type_of_screening='Cervical'.

Assess the client's need or desire for a chaperone. The presence of a chaperone or friend during these procedures may comfort the client and protect her and the RN from physical, emotional, or legal problems.

Ensure privacy. Make sure that the door to the exam room is closed and will not be opened from the outside.

During the Exam

Position the client so that you have eye contact with her. Talk to and provide her with reassurance throughout the exam.

Tell her what you are going to do before you do it, e.g. "I am going to touch the outside of your labia."

Reinforce to the client that anytime she feels uncomfortable you will stop until she tells you that you can proceed. Encourage the client to relax her inner thighs and flop her knees out to the side. Tell her that if she can keep her inner thighs relaxed that she will feel less pressure from the speculum. Avoid comments that may have sexual overtones, such as "spread your legs, dear." "I am going to stick it in now" and "I am coming out now."

Offer the client a mirror so that she can visualize what you are doing and give the client the opportunity to ask questions about her anatomy and the procedure.

Offer the client a sheet/drape for her knees if she chooses. Some women choose to have everything separated and some women prefer to have no obstruction so they can see what is going on.

Normalize the client's feelings and experience. Ask the client "How are you feeling about coming to have your Pap test today?" If the client indicates feeling embarrassed the RN can normalize her feelings and discuss the root of her concerns. If a client has, for example, poor hygiene, do not single her out, say, "Let me tell you what I tell all the women that I see - use a minimal amount of soap and wash regularly."

After the Exam

This is a great opportunity to reinforce learning and to answer any questions that the client may have. Ask the client to sit up on the exam table and if time permits, inform her that you will leave the room while she gets dressed and that you will return in a few minutes to discuss follow-up. If time does not permit, proceed to summarize and discuss the exam findings with the client. Discuss any concerns or findings that may need to be followed up by a Physician or Nurse Practitioner.

Follow protocols in your practice setting for the follow-up of all abnormal findings or suspected sexually transmitted infections.

Indicate how the client will receive the Pap test results. Pap test results usually go to the healthcare provider (i.e. Physician, Clinical Medical Director, Nurse Practitioner, or RN) for follow-up. It is the responsibility of the healthcare provider to inform the client of their abnormal Pap test results as soon as possible, and follow clinic/agency policies for abnormal results requiring referral to other providers. In addition, the ACCSP will send a result letter to all clients to inform them of their results, whether normal (sent immediately) or abnormal (sent within 3 weeks).

Explain to your client that she will receive a result letter in the mail from the ACCSP about 3-6 weeks after her test. Let her know she can call the program's toll-free number (1-866-727-3926) if she is not sure she wants to receive a result letter.

Elicit and respond to client questions and give the client written information and instructions as appropriate. Provide the client with relevant pamphlets to reinforce learning.

Section 4: Self-Test

1. What are 4 reasons that would influence an eligible client to not obtain a Pap test?

2. Discuss counselling and education strategies that are important to consider before (3 strategies), during (3 strategies) and after (3 strategies) conducting a Pap test.

SECTION 5: FACILITATING AN INCLUSIVE ENVIRONMENT

Learning Objectives

Upon completion of this Section, the learner will be able to

1. Identify the special learning, counselling and communication needs of specific groups.
2. Use inclusive language to create a safe and welcoming space.

Permission to reproduce in part or whole, for this section is given from CancerCare Manitoba, CervixCheck.

Clients with a History of Sexual Abuse

A Canadian study demonstrated that a history of sexual abuse may be associated with cervical cancer risk factors such as smoking and sexual intercourse at a young age. A history of sexual abuse may combine with other health determinants to have a significant impact on immediate and long-term health.³⁹

Some clients who are survivors of sexual abuse are very anxious about having a Pap test and may respond differently than those who have not suffered trauma.

Counseling and Education

Ensure the client has the opportunity to be referred to a counsellor. Check with your zone or facility policy and/or procedure manual for direction on follow-up and referral of clients with a history of sexual abuse.

During the Speculum and Pap test

Some clients don't recall or have suppressed knowledge of childhood sexual abuse. This may impact client comfort level without the ability to articulate why. Provide support and encourage the client to articulate feelings in a safe environment.

Ensure the client feels in control of the situation. Ask the client what would be helpful to make the Pap test easier. Give the client choice about positioning for the test, and reassure them that the test can be stopped at any point. The presence of a chaperone or attendant may comfort the client depending on the chaperone policy pertaining to your facility or region.

Talk the client through the exam. Ask the client to communicate to you about the test experience while it is occurring. Tell the client what you are going to do before you do it and provide reassurance. The phrases "let your knees go out to the side" or "let the muscles in your thighs go soft" are appropriate. The RN may have to further review how to relax the muscles. If this doesn't work and the client is so tense that it is difficult to insert the speculum, it may be best to stop the exam and defer it for another time. On a subsequent visit, remind the client that although the exam may be a reminder of the abuse, it is not the abuse, and the procedure may be difficult but that the HCP will proceed at the client's pace.

If the client experiences a flashback during the Pap test:

- Reassure the client that you believe her.
- Reassure the client of safety.
- Reassure the client that although she is re-experiencing the memories she is not re-experiencing the event.
- Examine the client only with permission.
- Ask the client specific questions related to the present to help ground the client in the moment.
- Never leave the client alone.
- Prepare visual cues to stop the exam (i.e. raise hand) if the client is unable to speak.
- Ensure follow-up and offer a referral to a counselor.

Lesbian Clients, WSW and Transgendered Clients

Clients who identify as lesbian, women who have sex with women (WSW), or transgender are a largely underscreened population in Canada. This is often due to a combination of the following reasons:

- A misunderstanding by the HCP and/or the client about whether cervical cancer screening is recommended.
- Poor representation or engagement by HCPs with lesbian and transgender individuals in their community.
- Homophobic attitudes and heterosexist assumptions reflected:
 - By the HCP;
 - In the clinic setting;
 - On the intake forms; and/or
 - During the health history by the HCP.

Transgender Clients

Due to social stigmatization and transphobia, transgender individuals lack access to primary medical services and preventative health care. Screening for cervical cancer may be necessary in this population. An atmosphere of privacy, trust and respect should be facilitated by the HCP.

Lesbian Clients and WSW

Lesbian clients and WSW are a subgroup that cut across all ages, races, social classes, and ethnic barriers. Lesbian clients can be isolated in society because of homophobia. Many lesbian clients avoid health care interactions because of fear of discrimination. To provide a positive health care experience for lesbian clients, it is important for the HCP to be aware of their unique health care needs. Lesbian clients and WSW have fewer Pap tests than heterosexual women. They also have a low incidence of sexually transmitted infections (STIs), vaginal infections, and cervical intraepithelial neoplasia (CIN). Nevertheless, they are still at risk, because:

- Lesbian clients or their partners may have had consensual or nonconsensual intercourse with men at some time (e.g. 77% of lesbians have one or more male sexual partners in their lifetime).
- HPV is transmissible in female to female sexual interactions and may be as prevalent in lesbian clients as it is in heterosexual clients.

Screening for cervical cancer among lesbian clients should be consistent with the screening guidelines and practices recommended for heterosexual clients.

Intake forms should:

Enable the client to identify their sexual orientation/identity in a way that represents their experience. For example:

INSTEAD OF	USE
Male <input type="checkbox"/>	Male <input type="checkbox"/>
Female <input type="checkbox"/>	Female <input type="checkbox"/>
	Gender: _____

During the Health History

- Ensure confidentiality.
- Use gender-neutral language.
- Facilitate an open dialogue about the client’s sexual orientation, sexual practices and gender identity.
- Approach the client with empathy.
- Attempt to create a positive rapport and atmosphere of trust.
- Do not make assumptions about the client.
- Ask if the client has had:
 - A Pap test before and if the experience was positive.
 - Penetrative sex to gauge a person’s comfort during the test.
- Avoid miscommunication by asking for clarification about concepts and terms when unfamiliar, without implying that the trans person needs to provide you with an education session.
- Consider the trans person’s biological sex at birth, identify what anatomy exists and approach/treat accordingly.
- Understand that:
 - Sexual reassignment surgery is not necessarily the end goal for trans people, and
 - Trans clients may or may not pursue a variety of different medical interventions.

Note: Changing the language we use is a simple way to create a safer, more inclusive environment. There is no perfect language to describe every person’s gender identity, but there are some general terms that aim to provide affirmation of a person’s state of alignment between their gender assigned at birth and current gender identity.



Using language that lessens the gender-izing of a person can help clients feel more accepted. For example, instead of using the term:

INSTEAD OF	USE
Boyfriend/Girlfriend	Partner
Vagina	Genital Opening
Menstruation	Bleeding
Vulva	External Pelvic Area
Panties	Underwear
Pap test	Cancer Screening
Him/Her	They

During the Pap Test

The presence of a chaperone or attendant may comfort the client. Inform the client of relevant chaperone policy pertaining to your facility or region.

- Ask “What would be helpful for you during this test?”
- Many trans men who are taking testosterone will have a less lubricated vagina. Lubricate the speculum with warm water prior to Pap test.
- Vaginal atrophy onset typically occurs at 3-6 months after initiating testosterone hormone therapy and peaks at 1-2 years.
- Proceed with as much of the Pap test as the client is comfortable with.
- Ensure any hormone therapy is noted on the cytology requisition form as it will impact how the cytotechnologist reads the specimen.

Access

As HCPs, there are several things that you and your staff can do to create a welcoming atmosphere for lesbian and transgender clients. These include:

- Featuring:
 - Signs, symbols and imagery of lesbian, gay, bisexual, transgender, queer and two-spirit (LGBTQ2S+) people on the door of the clinic, in clinic windows and inside the clinic (rainbow sticker, pink triangle, posters, campaign acknowledgement).
 - Distributing educational information specific to the LGBTQ2S+ clients in your clinic.
 - Media that positively reflect LGBTQ2S+ people.
- Providing gender neutral washrooms and change facilities.
- Posting a visible statement that communicates your intentions as a clinic to provide equal service to the LGBTQ2S+ communities and other marginalized populations.
- Encouraging staff and administration to partake in professional development and capacity building workshops that specifically address the issues and barriers of LGBTQ2S+ people.



Clients with Disabilities

Each disability affects each person differently. It is therefore important for RNs to educate themselves about relevant aspects of a client's disability. An RN's sensitivity in asking only pertinent questions about the disability will increase the client's comfort and cooperation.

Note: Consider if the University of Alberta Certificate in Sexual Health for those with Disabilities is applicable to your practice setting: <https://www.ualberta.ca/rehabilitation/professional-development/certificate-programs/certificate-in-sexual-health>

Clients with Physical Disabilities

Clothes should be removed from the waist down only. By only partially undressing, the client can conserve time and energy. Removing or rearranging the furnishings in the examination room will provide the space needed for a client to navigate a wheelchair.

The RN should consider:

- Access to the clinic.
- The height of the exam table.
- The client's physical limitations.
- Possible need of assistance for transfer.
- Alternate positioning for examination (Refer to [Section 8: External and Speculum Exam](#)).

Equipment such as obstetric foot supports, a high-low examination table, or a particularly wide examination table can be obtained to facilitate safer transfers and positioning.

Clients with Learning/Cognitive Disabilities Counseling and Education

When speaking with the client, the RN should remember to speak directly to her. Often people will address a client with a disability's friend, attendant or interpreter instead of speaking directly to the client. If the client's particular disability is cognitive, use visual strategies such as showing instruments and using 3D models.

The RN should consider:

- How to obtain informed consent.
- Involving the caregiver in communicating effectively with the client.
- Accepting that non-cooperation or distress of the client must be recognized as refusal or withdrawal of consent.

Clients with a Hearing Impairment

American Sign Language Interpretation (ASL) is available for deaf and hard of hearing Albertans. ASL interpreters are available in person in Calgary and Edmonton. They are available via telehealth (secure videoconference) to all other locations.

- To book an ASL interpreter, please call 1-866-471-2805 and follow the prompts.
 - This service is billed to the Provincial interpretation program and then billed back to the zones.

Vaginismus

Vaginismus is a condition by which clients experience persistent involuntary spasm of the vagina. Vaginismus often results in difficult and/or painful sexual intercourse, and in many cases intercourse is impossible. Clients with vaginismus also often experience discomfort when inserting a tampon, as well as when having an internal exam.

During the Speculum and Pap Test

Use a smaller speculum.

Reassure clients that if they feel uncomfortable at any time during the Pap test that you will stop and proceed only when it feels comfortable for you to do so.

Give the client control of the situation by giving choices:

- What would be helpful to make the Pap test easier?
- What position would be most comfortable?
- Give the client the option of not using foot supports.
- Offer the client the option of inserting the speculum.

Recommended Readings

Sexual Abuse Survivor Considerations

1. Canadian Women's Health Network [Suggestions for Physicians and Primary Care Nurses](#)
2. Canadian Women's Health Network [Getting Through Medical Examinations: A Resource for Women Survivors of Abuse and Their Health Care Providers](#)
3. Cancer Council Victoria [Female genital cutting \(FGC\) & cervical cancer screening: A guide for practitioners](#)

LGBTQ2S+ Considerations

1. Toward Optimized Practice [Transgender Health in Primary Care: Initial Assessment April 2019](#)
2. Rainbow Health Ontario, Sherbourne Health Centre <http://www.rainbowhealthontario.ca/>
 - [Trans Health Guide](#)
 - [Tips for Providing Paps to Trans Men](#)
3. University of California, San Francisco
 - [Screening for cervical cancer in transgender men](#)
 - [Transgender patients and the physical examination](#)

Indigenous Peoples Considerations

4. The College of Family Physicians of Canada [Health and Health Care Implications of Systemic Racism on Indigenous People in Canada](#)
5. The College of Family Physicians of Canada and the Society of Obstetricians and Gynaecologists of Canada Joint Policy Statement [Sexual and Reproductive Health, Rights, and Realities and Access to Services for First Nations, Inuit, and Métis in Canada](#)

Suggested Readings

1. Public Health Agency of Canada [Handbook on Sensitive Practice for Health Care Practitioners: Lessons from Adult Survivors of Childhood Sexual Abuse](#)
2. Society of Obstetricians and Gynaecologists of Canada [Female Sexual Health Consensus Clinical Guidelines](#)
3. Ross, L., Goldberg, J., Flanders, C., Goldberg, A., Yudin, M. (2018) [Bisexuality: The Invisible Sexual Orientation in Sexual and Reproductive Health Care](#)
4. National LGBT Health Education Center <http://www.lgbthealtheducation.org/>
 - [If you Have it, Check it: Overcoming Barriers to Cervical Cancer Screening with Patients on the FTM Trans Spectrum](#)
 - [Affirmative Care for Transgender and Gender Non-Conforming People: Best Practices for Front-line Health Care Staff](#)
5. Society of Obstetricians and Gynaecologists of Canada [Health Professionals Working with First Nations, Inuit, and Métis Consensus Guideline](#)

Public Sites:

- Canadian Cancer Society [Screening in LGBTQ Communities](#)

SECTION 6: HEALTH HISTORY

Learning Objectives

Upon completion of this Section, the learner will be able to:

1. Conduct a health history interview with women across the lifespan.
2. Tailor a health history interview to the client's needs, preferences, and presentation.

Note: Parts of this Section (Health History Review, Review of Related History) are adapted from Cervical Screening Initiatives Program of Newfoundland and Labrador (2001) and Mosby's Guide to Physical Examination⁴⁰ (p. 544-551) respectively. Used with permission.

Health History Review

Cervical cancer screening is a sensitive issue for some women. Certain risk factors may give women feelings of guilt, embarrassment, and confusion. Using a positive manner to discuss risk factors can give women the opportunity to voice health concerns and to take responsibility for their overall well-being by taking part in the cervical and other screening programs.

Adequate and accurate data are keys to a successful health history. It is necessary to be sensitive to culture, language and age related concerns, which if recognized, helps the RN to understand the client's responses and behaviour. Sometimes a phrase like "I am going to ask you some personal information that you may find uncomfortable, however this is normal and an important part of your cervical screening, I need to know ..." encourages the client to relax and assures her of the essential nature of such confidential information.

Terminology and language pose further barriers, you should:

- Be certain of what the client's statements mean.
- Repeat statements for verification, when necessary, so that misunderstandings can be corrected. For example, the client might complain of "itching down there" – use pictures/drawings to identify location or ask the client to point to the area.
- If language presents a problem, use an interpreter. Because of the confidential nature of the questions, a family member who is interpreting might be unsuitable.

If you are working at an AHS facility, use Interpretation and Translation Services to communicate with limited and non-English speaking patients/clients. Trained medical interpretation is available over the phone 24/7 and is available in over 240 languages. There is no cost to AHS sites and programs to access telephone interpretation services.

To access this service you must call a 1-800 number and the unique 6-digit access code for your work area. If you are unsure if your department or work area has signed up to access this services, please speak with your manager or find further contact information at

<https://insite.albertahealthservices.ca/its/Page10180.aspx>

During the reproductive health history interview, you should:

- Obtain health history data in a comfortable environment that protects the client's privacy.
- Conduct the interview at an unhurried pace; otherwise the client may overlook important details.
- To ensure the client's comfort and confidence, ask open-ended questions, preferably while the client is seated and dressed before the physical assessment.
- Ask questions to confirm that the client has understood; use terms that the client understands and explain technical/medical language.
- Focus questions on the reproductive system, but maintain a holistic approach by inquiring about the status of other body systems and psychosocial concerns. Reproductive system problems may cause the client other problems related to such other areas as self-image, sexual functioning, and overall wellness.
- When choosing health history questions, consider their relevance and practicality for the client as well as the clinical setting. For example, asking a 69 year-old client the date of her last menstrual period is pointless. Conversely, asking her about menopause, irregular bleeding, and estrogen replacement therapy may be more appropriate. Do not collect information from a client that is not going to be used or addressed. As well, do not collect information that is beyond what the client wants to disclose/discuss.

In some settings, the RN will not complete a comprehensive health assessment as described in this Section. When choosing your health history questions consider the relevance to the client and focus on their areas of concern.*

*It may be necessary to conduct a short focused health history to determine whether to proceed with a Pap test or refer to a Physician. Only go into more depth if there are concerns relative to Pap testing (e.g. previous abnormal Pap tests, past gynecologic procedures such as cone biopsy or hysterectomy, intermenstrual spotting, previous problems with Pap tests such as pain, more specific questions about current genital infections, discharge). If a client does have a concern, symptoms, or a history that could indicate cervical pathology, STI, and/or other abnormal findings, she should be referred to a Physician and/or Nurse Practitioner for further investigation.

Review of Related History

The following health history components are recommended for a comprehensive well-woman Pap test visit focused on sexual and reproductive health. RNs need to use their clinical judgement within the context of their practice setting to determine what information is necessary from each woman and how/whether to use more detailed questions with individual clients based on client need/request/disclosure.

1. Menstrual History

- Age at menarche.
- Date of last menstrual period: first day of last cycle.
- Number of days in cycle and regularity of cycle.
- Character of flow: amount (number of pads or tampons used in 24 hours), duration, presence and size of clots.

- Dysmenorrhea: characteristics, duration, frequency (occurs with each cycle?), relief measures.
 - Intermenstrual bleeding or spotting: amount, duration, frequency, and timing in relation to phase of cycle.
 - Intermenstrual pain: severity, duration, timing, and association with ovulation.
 - Premenstrual symptoms (PMS): headaches, weight gain, edema, breast tenderness, irritability or mood changes, frequency (occurs with every cycle?), interference with activities of daily living, relief measures.
2. Obstetric History
- Gravity (number of pregnancies).
 - Parity (number of births); term, pre-term.
 - Abortions: spontaneous or induced.
 - Number of living children.
 - Complications of pregnancy, delivery, abortion, or with fetus/neonate.
3. Douching History
- Douching within the last 24 hours.
 - Frequency: length of time since last douche; number of years, douching method and solution used.
 - Reason for douching.
4. Contraceptive History
- Sexual intercourse, use of birth control creams/jellies, or lubricant within the last 24 hours.
 - Current method: length of time used, effectiveness, consistency of use, side effects, and satisfaction with method.
 - Previous methods: duration of use for each, side effects, and reasons for discontinuing each.
5. Sexual History
- Difficulties, concerns, problems (post coital bleeding).
 - Dyspareunia: characteristics, duration and frequency.
 - Date of last STI testing (when appropriate to ask).
6. Medical History
- Date of last pelvic examination.
 - Date of last Pap test and results.
 - HPV vaccination record (when appropriate).
 - Medications: prescription, over-the-counter, illicit drug use.
 - Past gynaecologic procedures or surgery (tubal ligation, hysterectomy, oophorectomy, laparoscopy, cryosurgery, laser therapy, LEEP, cervical conization, including cosmetic).
 - Sexually transmitted infections.
 - Pelvic inflammatory disease.
 - Vaginal infections.
 - Tobacco use.
 - Female circumcision (female genital cutting).
 - Sexual reassignment surgery and/or hormone therapy.

Section 6: Self-Test

1. Describe the 6 key areas to review when conducting a health history.

SECTION 7: PHYSIOLOGY, ANATOMY, AND ABNORMAL FINDINGS

Learning Objectives

Upon completion of this Section, the learner will be able to:

1. Describe normal developmental changes associated with female genitalia.
2. Describe the external and internal anatomy and physiology of the female.
3. Identify abnormal findings and indications of STI, and when referral is necessary.
4. Recognize variations of female genital mutilation.

⁴⁰Note: Parts of this Section (Menstrual Cycle, Developmental Changes) are adapted from Cervical Screening Initiatives Program of Newfoundland and Labrador (2001) and Mosby's Guide to Physical Examination⁴⁰ (p. 553-564) respectively. Used with permission.

Menstrual Cycle

The menstrual cycle is a complex process involving the reproductive and endocrine systems. The average menstrual cycle usually occurs over 28 days, although the normal cycle may range from 22 to 34 days. Fluctuating hormone levels that, in turn, are regulated by negative and positive feedback mechanisms, regulate the menstrual cycle. The phases are described below:

Menstrual (Preovulatory) Phase

The cycle starts with menstruation (cycle day 1), which usually lasts approximately 5 days. As the cycle begins, low estrogen and progesterone levels in the bloodstream stimulate the hypothalamus to secrete gonadotropin-releasing hormone (GnRH). In turn, GnRH stimulates the anterior pituitary to secrete follicle-stimulating hormone (FSH) and luteinizing hormone (LH). When the FSH level rises, LH output increases.

Proliferative (Follicular) Phase and Ovulation

The proliferative phase lasts from cycle day 6 to 14. During this phase, LH and FSH act on the ovarian follicle (mature ovarian cyst containing the ovum), stimulating estrogen secretion. This causes the endometrium to thicken and become more vascular. Late in the proliferative phase, estrogen levels peak, FSH secretion declines, and LH secretion increases, surging at midcycle (around day 14), stimulating ovulation. Then, estrogen production decreases, the follicle matures, and ovulation occurs. Normally, one follicle matures during the ovulatory process and is released from the ovary during each cycle.

Luteal (Secretory) Phase

During the luteal phase, which lasts about 14 days, FSH and LH levels drop. Estrogen levels decline initially, and then increase along with progesterone levels as the corpus luteum (progesterone-producing yellow structure that develops on the surface of the ovary, after the follicle ruptures) begins functioning. During this phase, the endometrium responds to progesterone stimulation by becoming thick and secretory in preparation for implantation of a fertilized ovum.

About 10 to 12 days after ovulation, when the ovum has not been fertilized, the corpus luteum begins to diminish as do estrogen and progesterone levels, until the hormone levels are insufficient to sustain the endometrium in a fully developed secretory state. Then the ovum disintegrates, and the endometrial lining is shed (menses). This product consists of old blood, mucus and endometrial tissue. Decreasing estrogen and progesterone levels stimulate the hypothalamus to produce GnRH, and the cycle begins again.

Developmental Changes in the External and Internal Genitalia

Over a woman's lifetime, the size of the uterine corpus and cervix change. For example, of the space filled by the whole uterus in a premenarchial female, one third may be uterine corpus, and two thirds may be cervix. In the adult multiparous female, the uterine corpus may occupy two thirds of the space available, whereas the cervix may fill a third.

Adolescent Women

External genitalia during puberty	Internal Genitalia during puberty
Increase in size.	Vagina lengthens, and epithelial layers thicken; vaginal secretions become acidic.
Clitoris becomes more erectile.	Uterus, ovaries, and fallopian tubes increase in size and weight; uterine musculature and vascular supply increase.
Labia minora becomes more vascular.	Endometrial lining thickens in preparation for the onset of menstruation (menarche), which usually occurs between the ages of 8 and 16 years.
Labia majora and mons pubis become more prominent and begin to develop hair often occurring simultaneously with breast development.	Vaginal secretions increase just before menarche.
If the hymen is intact; the vaginal opening is about 1 cm in size.	Functional maturation of the reproductive organs is reached during puberty.

Older Women

- Ovarian function diminishes during a client's 40's.
- Ovulation usually ceases about 1 to 2 years before menopause.
- Menstrual periods begin to ease between 40 and 55 years of age although fertility may continue.
- Menopause is conventionally defined as completed after 1 year of no menses.

Changes in external genitalia	Changes in internal genitalia
Estrogen levels decrease, causing the labia and clitoris to become smaller.	Vaginal introitus gradually constricts.
Labia majora also become flatter as estrogen levels decrease and/or body fat is lost.	Vagina narrows, shortens, and loses lubrication, and the mucosa becomes thin, pale, and dry, which may result in dyspareunia and/or vaginal atrophy.
Pubic hair turns gray and is usually sparser.	Vaginal walls may lose some of their elasticity, cervix becomes smaller and paler.
	Uterus decreases in size, and the endometrium thins.
	Ovaries also decrease in size to approximately 1 to 2 cm.
	Ligaments and connective tissue of the pelvis sometimes lose their elasticity and tone, thus weakening the supportive sling for the pelvic contents.

Pregnant Women

If a client indicates that she is pregnant or the RN suspects pregnancy during the history or physical exam, she should be referred to a Physician, Nurse Practitioner, or Registered Midwife for ongoing pre and postnatal care. **Pregnant woman only need Pap tests if they are otherwise due for screening.**

External Genitalia

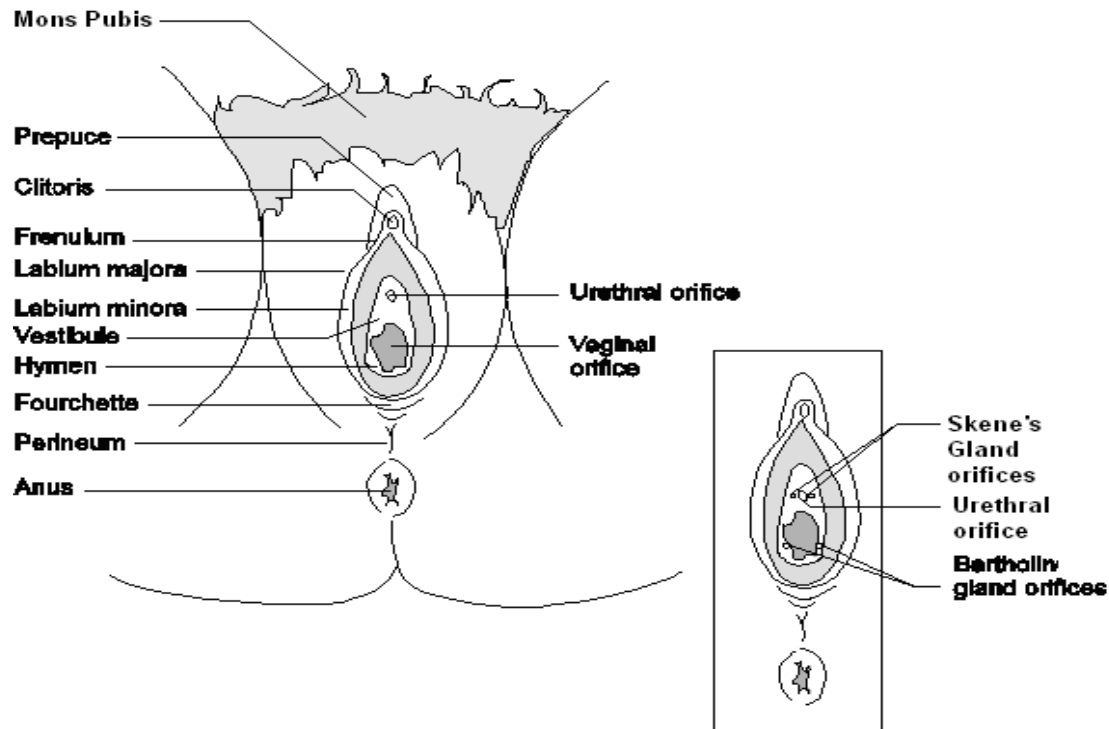

Figure 5: View of External Genitalia

From: Faculty of Primary Care Nurse Practitioner Program, SIAST (2000). *Pap Testing and Bimanual Exam*, p. 9. Reprinted with permission.

Mons Pubis

The **mons pubis** is the cushion of adipose and connective tissue covered by skin and coarse, curly hair in a triangular pattern over the symphysis pubis.

Abnormal Findings:

- Excessive hair associated with excessive hair elsewhere.
- Absence of hair in a client >16 may suggest abnormality, however it is common for young women to shave their pubic hair.

Urethral Orifice

The **urethral orifice** is normally pink with no excretion.

Abnormal findings:

- Erythema.
- Abnormal exudates.
- Abnormal mass within or upon the orifices.

Vaginal Orifice and Skene's Glands

When the labia are spread, the **vaginal orifice** (introitus) and the urethral meatus are visible. Less easily visible (normally invisible) are the multiple orifices of **Skene's glands** (paraurethral glands), mucus-producing glands located on both sides of the urethral opening.

Abnormal findings:

- Visible Skene's gland orifice.
- Erythema.
- Abnormal exudates.
- Abnormal mass situated within or upon the orifice.

Bartholin's Gland Orifices

Openings of the two mucus-producing **Bartholin's glands** are located laterally and posteriorly on either side of the inner vaginal wall. Orifices of the Bartholin's glands are normally not visible.

Abnormal findings:

- Erythema.
- Abnormal exudates.
- An abnormal mass.

Clitoris

The **clitoris** is the sensitive organ of sexual stimulation formed by erectile tissue. It is covered by the prepuce, which along with the frenulum is formed by the merged, inner parts of the labia minora. The adult clitoris is normally no greater than 0.5 cm. in diameter.

Abnormal findings:

- Enlargement.
- Atrophy.
- Any abnormal mass.

Frenulum

The **frenulum** is the protective tissue covering the clitoris.

Abnormal findings:

- Abnormal mass within or upon the frenulum.

Labia Majora and Minora

The **labia majora** border the vulva laterally from the mons pubis to the perineum. The **labia minora**, two moist smaller mucosal folds of delicate darker pink to red tissue, lie within the labia majora. They are made up of dense connective and erectile tissue. The labia majora and minora are usually symmetrical but vary in size per client. Before menarche, the labia majora



are poorly defined, and with the menopause, they atrophy. In a client of reproductive age, they are prominent.

Abnormal findings of labia majora or minora:

- Asymmetry or unusual enlargement.
- Abnormal exudates.
- Focal hyperpigmentation.
- Sebaceous cyst - blocked opening of sebaceous gland evident by a small firm round nodule on the labia. Often yellow in color with a dark center.
- Depigmentation.
- Erythema.
- Excoriations.
- Ulcerations.
- Leukoplakia may signify precancerous growth.

Abnormal findings of the labia majora only are:

- Atrophy before menopause.
- Lack of prominence in a client over 16 years old.

Vestibule

The **vestibule** is the space between labia minora, clitoris and the **fourchette**. It contains the vaginal opening, Skene's glands, and the hymen.

Hymen

The hymen, a tissue membrane varying in size and thickness, may completely or partially cover the vaginal orifice. Hymens that completely cover the vaginal orifice will normally contain a small aperture. An imperforate hymen may cause the retention of menstrual blood in the vaginal canal.

Perineum

The **perineum** is the structure constituting the pelvic floor and is referred to as the distinct bridge of tissue that separates the vaginal and **anal** orifices. It narrows as a result of vaginal delivery. It is usually smooth and unbroken however you may note a scar from a previous episiotomy or tear.

Abnormal findings:

- Extreme narrowing of the perineum.
- Fistula.
- Bulging.
- Abnormal mass.

Vaginal Orifice

Also called the **introitus**. No part of the vaginal walls is normally visible through the vaginal orifice, unless the orifice is gaping as the result of one or more vaginal deliveries.

Cystocele: prolapse of the urinary bladder through the **anterior wall** of the vagina, sometimes even exiting the introitus. The bulging can be seen and felt as the client bears down. More severe degrees of cystocele are accompanied by urinary stress incontinence.

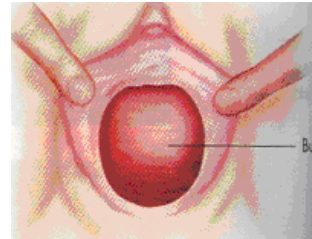
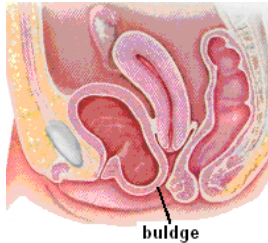

Reprinted from Mosby's Guide to Physical Examination, Seidel et al., (2011) with permission from Elsevier.

Rectocele: prolapse of part of the rectum through the **posterior wall** of the vagina is called rectocele or proctocele. Bulging can be observed and felt as the client bears down.

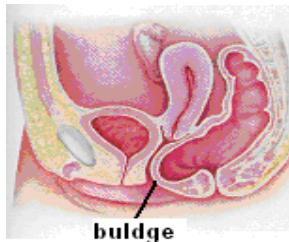

Reprinted from Mosby's Guide to Physical Examination, Seidel et al., (2011) with permission from Elsevier.

Internal Genitalia

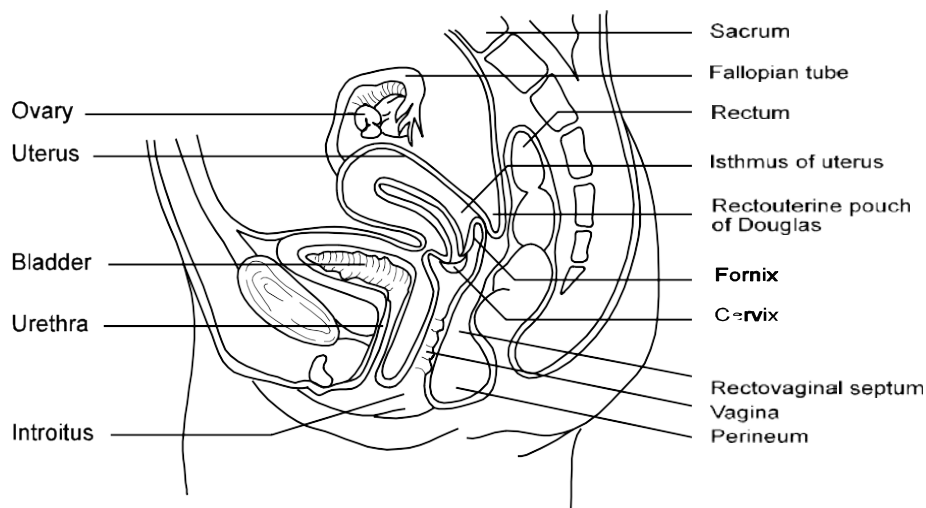

Figure 6: Lateral View of Internal Genitalia

From Faculty of Primary Care Nurse Practitioner Program, Saskatchewan Institute of Applied Science and Technology (2000). Pap Testing and Bimanual Exam, p. 14. Reprinted with permission.

Vagina

The **vagina** is a hollow, highly elastic muscular tube extending between the urethra and rectum upward and back. The vaginal epithelium is normally continuous and unbroken and covered with epithelium fluid or transudate that is clear, colourless, and odourless. Blood is normal if it is menstrual. Before menopause the mucosa is pink; after menopause, paler. During pregnancy, the epithelium may appear cyanotic because of underlying venous congestion. In a nulliparous client, the vaginal mucosa typically displays rugations (wrinkles) that become less prominent after a vaginal delivery.

Abnormal findings:

- Abnormal masses or exudates.
- Blood of unknown origin.
- Cyanosis in a nongravid client.
- Erythema.
- Genital warts.
- Fistula.
- Hemorrhagic lesions.
- Leukoplakia.
- Nodularity.
- Pallor in a premenopausal client.
- Ulceration.
- Atrophic vaginitis – in older females, atrophy of the vagina is caused by lack of estrogen. The vaginal mucosa is usually dry and pale, but it may become reddened and develop petechiae and superficial erosions. The accompanying vaginal discharge may be white, gray, yellow, green, or blood-tinged. It can be thick or watery.

Fornices

The recess anterior to the cervix is called the **anterior fornix**, the one posterior to the cervix is the **posterior fornix**, and the one on either side of the cervix is the **lateral fornix**.

Uterus

The uterus is a small, firm, pear-shaped, and fibromuscular organ. It is about 7.5 cm. long, rests between the bladder and the rectum and usually lies at almost a 90-degree angle to the vagina.

The uterus is divided into the following three layers:

1. Perimetrium: external layer made up of a serous membrane.
2. Myometrium: middle layer made up of a heavy muscular wall.
3. Endometrium: internal lining which responds to changing estrogen and progesterone levels during the menstrual cycle.

The uterus has two parts: 1) the **cervix**, which projects into the vagina, and 2) the **fundus**, which is the larger, upper part. In pregnancy the elastic, upper uterine portion (the fundus) accommodates most of the growing fetus. The uterine neck (isthmus) joins the fundus to the

cervix. The fundus and the isthmus make up the corpus, the main uterine body. The size of the uterus varies depending on the number of births (parity) and uterine abnormalities. The uterus is anteverted or anteflexed above or over the empty bladder in most women, but can also be midplane (its long axis parallel to the long axis of the body), retroverted, or retroflexed.

Abnormal findings:

- Asymmetry.
- Enlargement in a nongravid client.
- Lateral displacement.
- Limited mobility.
- Any abnormal mass.

Uterine prolapse occurs when the supporting structures of the pelvic floor weaken. This often occurs concurrently with a cystocele or rectocele. The uterus becomes progressively retroverted and descends into the vaginal canal. In first-degree prolapse the cervix remains within the vagina; in second-degree prolapse the cervix is at the introitus; in third-degree prolapse the cervix drops outside the introitus. See illustrations below:



Normal uterus

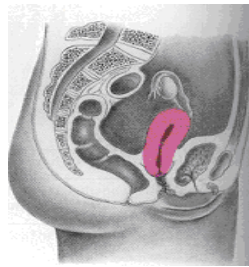

First-degree prolapse



Second-degree prolapse

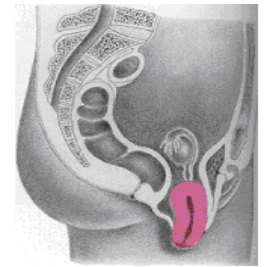

Complete prolapse

Reprinted from Mosby's Guide to Physical Examination, Seidel et al., (2011) with permission from Elsevier.

Uterine cancer in most cases develops in the glandular tissue of the endometrium and is called adenocarcinoma.⁴¹ Having the following signs and symptoms does not necessarily indicate uterine cancer, but may require more discussion in the health history and should be assessed and referred to a Physician or Nurse Practitioner.

Early uterine cancer symptoms:

- Bleeding between menstrual periods
- Heavy bleeding during periods
- Spotting or bleeding after menopause
- Bleeding after intercourse
- A foul discharge
- Yellow watery discharge
- Cramping pain
- Pressure in abdomen or pelvis, back or legs
- Discomfort over the pubic area

Adapted from the Canadian Cancer Society⁴¹

Post-menopausal bleeding (bleeding after the first complete year without a period) is considered a high risk factor for endometrial cancer and the client should be referred to a Physician and possibly referred for an endometrial biopsy and pelvic ultrasound. **The client should be told to watch for this so if this does occur she should contact her Physician or Nurse Practitioner.**

Fallopian Tubes

From each side of the fundus extends a fallopian tube, a narrow tube of muscle fibers that is generally 8 -14 cm long and non-palpable. Finger-like projections, called fimbriae, create a fringed, funnel-shape at the end that partially surround the ovaries. Fertilization of the ovum usually occurs in the outer third of the Fallopian tube.⁴⁰

Ovaries

The ovaries are almond-shaped structures that vary considerably in size but average about 3 – 3.5 cm long, 2 cm wide and 1 – 1/5 cm thick from adulthood through menopause. They lie near the lateral pelvic walls, a little below the anterosuperior iliac spine. The two primary functions of the ovaries are to produce ova and secrete hormones, including estrogen, progesterone, and testosterone. About 300 ova are released during a woman’s childbearing years.

Ovarian cancer can develop for a long time without causing any signs or symptoms.⁴² When symptoms do start, they are often vague and easily mistaken for more common illnesses. Most women with ovarian cancer have advanced disease at the time of their diagnosis. To date there is no effective way of detecting ovarian cancer early and no effective ovarian cancer screening methods. Although bimanual exam is not a part of this module, the RN should be aware of signs of ovarian cancer. Having the following symptoms does not necessarily indicate ovarian cancer, but may require more discussion in the health history and a possible referral to a Physician or Nurse Practitioner.

Early ovarian cancer symptoms:

- Mild abdominal discomfort or pain
- Abdominal swelling
- Change in bowel habits
- Feeling full after a light meal
- Indigestion & gas
- Upset stomach
- Sense that bowel has not completely emptied
- Nausea
- Constant tiredness
- Pain in lower back or leg
- Abnormal menstrual or vaginal bleeding
- More frequent urination
- Pain during intercourse
- Persistent cough

Adapted from the Canadian Cancer Society⁴²



Cervix

The cervix normally protrudes into the vaginal vault by 1 to 3 cm. In a nulliparous client, its diameter is 2 to 3 cm. and following vaginal delivery increases in size to 3 to 5 cm. It is usually round and symmetrical in shape. A round (in nulliparous clients) or slit like (in parous clients) depression is the external os of the cervix and marks the opening into the **endocervical canal** (passage way between the cervix and the uterus) and uterine cavity. The trauma of a delivery may tear the cervix, producing permanent transverse or stellate lacerations.

The **ectocervix** is the lower part of the cervix that protrudes into the vagina. The **transformation zone** where the Pap test sampling needs to focus varies for each woman and is somewhere between the ectocervix and the endocervical canal.

The upper vagina is divided by the protrusion of the cervix into the vagina into vault-like anterior (front) fornix and posterior (back) fornix. The position of the cervix in the vagina has implications for the placement of the speculum during a pelvic exam.

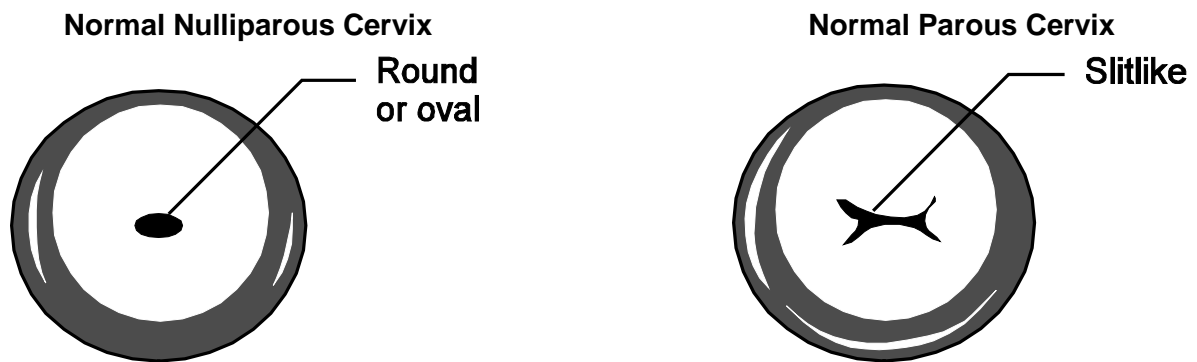

From Faculty of Primary Care Nurse Practitioner Program, Saskatchewan Institute of Applied Science and Technology (2000). Pap Testing and Bimanual Exam p 17-19. Adapted with permission.

Anatomy of the Cervix as a whole

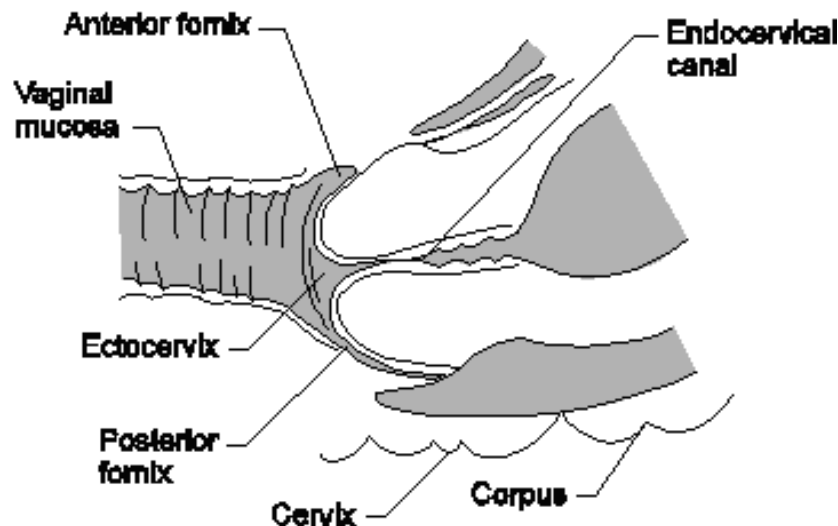

From Faculty of Primary Care Nurse Practitioner Program, Saskatchewan Institute of Applied Science and Technology (2000). Pap Testing and Bimanual Exam, p. 16. Reprinted with permission.

Common findings:

- Nabothian follicles - mucus retaining cysts caused by normal changes of surface columnar squamous epithelium. They are usually small (5mm diameter) but occasionally may enlarge to 1.5 cm. If several are present the cervix may have a knobby appearance.
- Polyp - bright red, soft growth emerging from os. It is a benign lesion, but must be determined by biopsy. There may be discharge or bleeding.

Nabothian Follicles



Cervical Polyps



From Burghart, E. (1991). Colposcopy, Cervical Pathology: Textbook and Atlas, 2nd Ed. Reprinted with permission.

Abnormal findings of the cervix as a whole:

- Asymmetrical shape.
- Enlargement not attributable to a vaginal delivery.
- An abnormal mass.
- Protrusion into the vaginal vault by more than 3 cm.

Ectocervix

The ectocervix is covered with smooth **squamous** epithelium that is normally moist with a clear, colorless fluid. In some women, the epithelial color is uniformly pink, and in others, an erythema surrounds the cervical os. Usually, it appears:



- Flat.
- Pink.
- Uniform.
- Featureless.

From Burghart, E. (1991). Colposcopy, Cervical Pathology: Textbook and Atlas, 2nd Ed. Reprinted with permission.

Endocervix

A columnar, mucus producing epithelium lines the cervical canal. The **columnar** epithelium extends proximally from the squamo columnar junction (SCJ) to the endocervical canal and internal os. It covers a variable amount of the **ectocervix** and lines the **endocervical canal**.

The endocervix:

- Is irregular.
- Seems dark red because of the underlying vessels.
- Produces mucus that is more profuse, clear, and watery just before ovulation.
- Produces mucus that is thicker, duller and more tenacious after ovulation or during pregnancy.

Cervical Epithelium

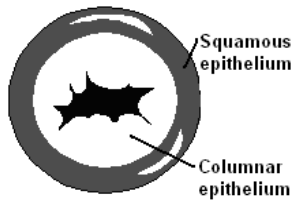

From Faculty of Primary Care Nurse Practitioner Program, Saskatchewan Institute of Applied Science and Technology (2000). Pap Testing and Bimanual Exam, p. 22. Reprinted with permission.

Columnar Epithelium



From Burghart, E. (1991). Colposcopy, Cervical Pathology: Textbook and Atlas, 2nd Ed. Reprinted with permission.

Squamo Columnar Junction (SCJ)

The SCJ of the cervix is the area of change or line along which the squamous epithelium of the ectocervix meets the columnar epithelium of the endocervix. The SCJ is often marked by a line of metaplasia (see transformation zone below) and its location is variable. Age and hormonal status are the most important factors influencing its location. For example, it may be located:

- At or very close to the external os during **perimenarche**.
- On the ectocervix at variable distances from the os in **reproductive-aged women**.
- Further away from the os as high estrogen levels during pregnancy **and with oral contraceptive use** promote further eversion of the SCJ.
- Receding up the endocervical canal from the **perimenopause** on, or with prolonged exposure to strong progestational agents which cause atrophy.
- Receding into the endocervical canal (inverted) and cannot be readily visualized during post **menopause**.



Transformation Zone

This is the area of transformation where **squamous** epithelium of the ectocervix has replaced **columnar** (glandular) epithelium of the endocervix through the process of squamous metaplasia. The SCJ discussed above is the visible border between the squamous and columnar epithelia of the cervix and represents the **new** squamocolumnar junction. Adjacent to the new SCJ the dynamic process of **squamous metaplasia** occurs throughout the reproductive years. This is a normal process during which **columnar epithelium is replaced by squamous epithelium**.

The transformation zone includes the area between the original squamocolumnar junction and the new squamocolumnar junction and has a variegated appearance. This zone:

- Is located 8mm to 13mm proximal to the ectocervix, but may extend as far as 20mm to 30mm into the cervical canal.
- Is higher within the cervix in older women and those who are pregnant.

Transformation Zone



From Burghart, E. (1991). Colposcopy, Cervical Pathology: Textbook and Atlas, 2nd Ed. Reprinted with permission.

Variations in the Transformation Zone

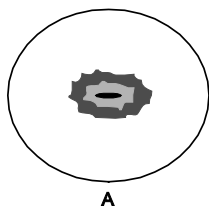

A

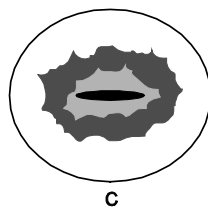

B

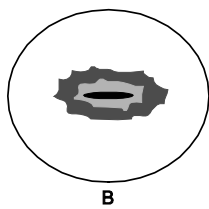

C

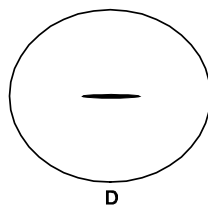

D

- A. Narrow transformation zone.
- B. Broader transformation zone—parous.
- C. Broadly everted transformation zone—parous.
- D. Post-menopausal (indrawn) or post-treatment type.

From Faculty of Primary Care Nurse Practitioner Program, Saskatchewan Institute of Applied Science and Technology (2000). Pap Testing and Bimanual Exam, p. 21. Reprinted with permission.

Cervical Epithelium (Lateral View)

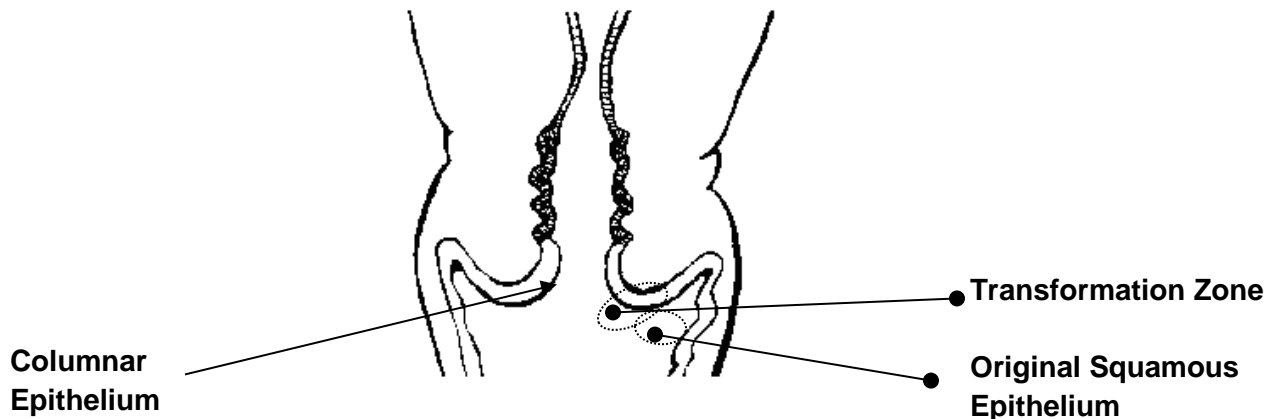

Adapted from Faculty of Primary Care Nurse Practitioner Program, Saskatchewan Institute of Applied Science and Technology (2000).

Abnormal findings:

- Abnormal exudates or masses upon the ectocervix.
- Asymmetrical circumoral erythema with irregular borders.
- Blood of unknown origin.
- Cyanosis in a nongravid client.
- Diffuse erythema.
- Ulcerations.
- Nodularity or roughness is usually abnormal, but may be attributable to nabothian cysts which are common.
- Hemorrhagic lesions.
- Leukoplakia.

Cervical Punctation (Carcinoma in situ) - Vertical, single-loop capillaries viewed end-on.



From Burghart, E. (1991). Colposcopy, Cervical Pathology: Textbook and Atlas, 2nd Ed. Reprinted with permission.

Mosaicism (Carcinoma in situ) - Tile like pattern of vessels around blocks of white epithelium caused by neovascular changes. Coarser patterns and vessels indicative of higher grade lesions.



From Burghart, E. (1991). Colposcopy, Cervical Pathology: Textbook and Atlas, 2nd Ed. Reprinted with permission.

Extensive erosion and severe dysplasia



From Burghart, E. (1991). Colposcopy, Cervical Pathology: Textbook and Atlas, 2nd Ed. Reprinted with permission.

Summary Chart: Identifying Normal and Abnormal Cervical Appearances ([download](#))



Alberta Cervical Cancer Screening Program

Identifying Normal and Abnormal Cervical Appearances

Below are examples of cervixes that may be seen during a Pap test. Any visual cervical abnormalities and/or symptoms (i.e. abnormal bleeding or discharge) must be investigated regardless of the Pap test result.



Atrophy



Cervical polyps



Decidual polyp



Endocervical polyp



Nabothian follicles



Normal with extensive ectropion

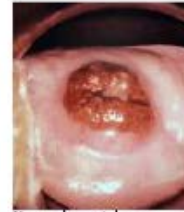

Normal, post-laser



Transformation zone



Cervical ulcer



Normal with IUCD



Normal with ectropion



Normal



Cervical carcinoma



Cervical carcinoma



Cervical carcinoma



Cervical carcinoma

Images taken from:
1. Burghart, E. (1996). *Colposcopy, Cervical Pathology: Textbook and Atlas, 2nd Ed.*
2. LITVIN, D., E. Pap Test Learning Module: Carcinoma of the Cervix (Y1004) (1997). Accessed at www.getcheckedmanitoba.ca on October 10, 2014.

Used with permission from Cervix Check CancerCare Manitoba

Female Genital Mutilation (FGM)

Some cultures traditionally excise women's genitalia as a puberty rite or means of preserving virginity until marriage. Women who have undergone this practice may have many related negative health consequences. The World Health Organization⁴³ has different classifications based on the extent of FGM:

- Type I: Excision of the prepuce with or without excision of part or all of the clitoris (clitoridectomy).
- Type II: Excision of the prepuce, clitoris and labia minora with partial or total excision of the labia majora (excision).
- Type III: Excision of part or all of the external genitalia and stitching/narrowing of the vaginal opening (infibulation).
- Type IV: Unclassified: includes pricking, piercing or incision of clitoris and/or labia; stretching of clitoris and/or labia; cauterization by burning of clitoris and surrounding tissues; scraping of the vaginal orifice or cutting of the vagina; introduction of corrosive substances into the vagina to cause bleeding or herbs into the vagina with the aim of tightening or narrowing the vagina; any other procedure which falls under the definition of FGM given above.

Clitoridectomy: The prepuce and head of the clitoris is removed.

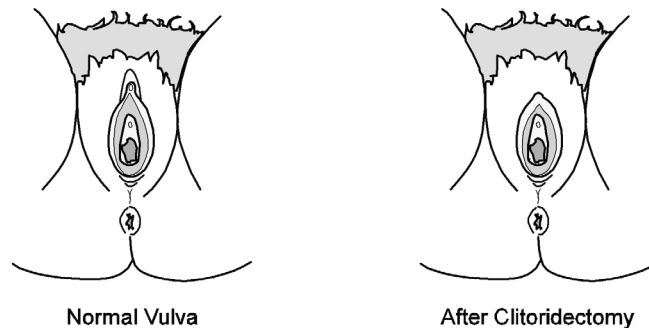

From Faculty of Primary Care Nurse Practitioner Program, Saskatchewan Institute of Applied Science and Technology (2000). Pap Testing and Bimanual Exam, p. 12. Reprinted with permission.

Excision: Removal of the entire head of the clitoris and labia minora.

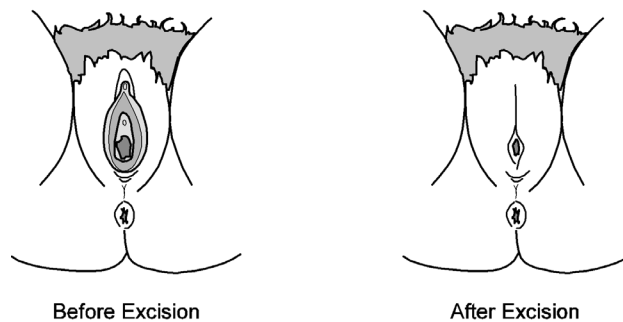

From Faculty of Primary Care Nurse Practitioner Program, Saskatchewan Institute of Applied Science and Technology (2000). Pap Testing and Bimanual Exam, p. 13. Reprinted with permission.

Infibulation: Removal of the entire external genitalia

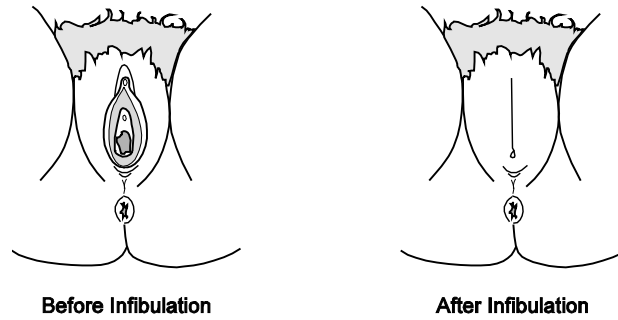





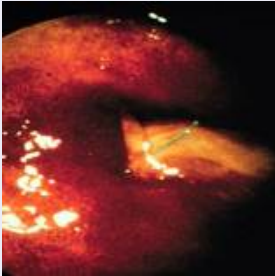

From Faculty of Primary Care Nurse Practitioner Program, Saskatchewan Institute of Applied Science and Technology (2000). Pap Testing and Bimanual Exam, p. 13. Reprinted with permission.

Summary Chart: Discharges, Infections, Ulcers, and Lesions

Any abnormalities or suspected infections of the vulva, vagina or cervix should be appropriately documented and the client should be reported immediately to a Physician, or Nurse Practitioner for follow-up and further testing. Details about STI testing are not included in this module although it is considered a normal part of a well woman’s exam (depending on age and risk factors). If you are required, by your clinic/agency, to conduct STI testing please refer to your clinic/agency guidelines.

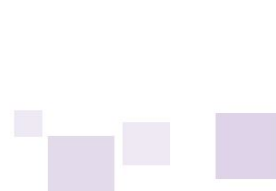
Vaginal Discharges and Infections				
Name	Discharge	Erythema/Itching	Associated symptoms	Picture (if available)
Gonorrhea	Often clients will be asymptomatic. Thick yellow/green discharge or discharge may be absent. May manifest with urethritis, cervicitis, and pelvic inflammatory disease (PID).	Cervix and vulva may be inflamed. May have cervical friability (bleeding when the first swab is taken) and/or erythema or edema.	Dysuria, frequency, abnormal vaginal bleeding, lower abdominal pain, deep dyspareunia, Bartholin gland inflammation, and discharge. If left untreated may result in infertility.	

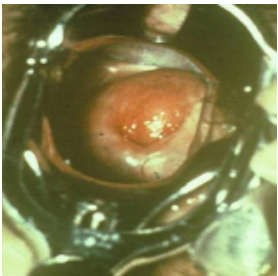
<p>Chlamydia</p>	<p>Often asymptomatic. Color of discharge may vary greatly (e.g. may see yellow mucopurulent discharge from cervical os). May manifest with urethritis, cervicitis, and PID.</p>	<p>Hypertrophic, edematous, may have cervical friability and/or erythema or edema.</p>	<p>Intermenstrual spotting, spotting after intercourse, asymptomatic urethritis, deep dyspareunia, abnormal vaginal bleeding, lower abdominal pain. If untreated may result in infertility.</p>	
<p>Gardnerella</p>	<p>Scant or moderate discharge. May be grey with foul odor.</p>	<p>Usually no edema or erythema of vulva or vagina. Vaginal epithelium may be red, swollen, tender, and the client complains of burning and itching.</p>	<p>Strong fishy vaginal odor, particularly after intercourse.</p>	
<p>Candidiasis</p>	<p>Scant to moderate discharge. May be thin but usually thick, white, curdy cheese like discharge which is adherent to vaginal wall/cervix.</p>	<p>Mild to severe itching and erythema of labia, thighs, perineum. Cervix may be red and edematous. Erythema and edema of vulva, vagina or introitus. Vagina may have white patches, some which may detach.</p>	<p>Dysuria, frequency, dyspareunia.</p>	
<p>Trichomoniasis</p>	<p>Copious, frothy, grey, green, yellow white or yellow brown discharge, strong foul odor.</p>	<p>Severe itching of vulva, with or without erythema. Petechiae of cervix and vagina (“strawberry spots”). The cervix may be inflamed and friable.</p>	<p>Dysuria and dyspareunia with severe infection.</p>	
<p>Bacterial Vaginosis</p>	<p>Grey to white, thin, watery discharge.</p>	<p>May have burning or irritation around vagina.</p>	<p>“Fishy” smelling odor.</p>	

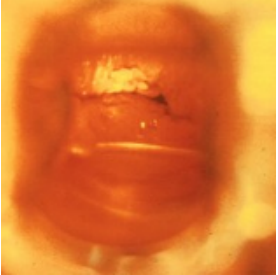
Genital Ulcer Disease				
Name	Discharge	Erythema/Itching	Associated symptoms	Pictures (if available)
Syphilis	Secondary - Papules covered by gray exudate.	Syphilitic Chancre (Primary Syphilis) can appear as a single painless, indurated ulcer found on the genitals. Most chancres in women develop internally and often go undetected. Condyloma Latum (Secondary Syphilis) lesions appear 2 to 12 weeks after infection. They are flat, round, or oval.		
Genital Herpes (can be due to herpes simplex virus HSV-2 or HSV-1)	Clear watery discharge from early blister-like lesions.	Usually starts with painful papules followed by vesicles (blisters), ulceration, crusting, and healing. The lesions may itch and are usually painful.	Dysuria, swollen glands in groin, outbreaks vary and can return as often as every month or as rarely as once a year or longer. Initial infection is often extensive, whereas recurrent infection is usually confined to a small localized patch on the vulva, perineum, vagina, anus, or cervix.	
Papular Genital Lesions				
Name	Discharge	Erythema/Itching	Associated symptoms	Pictures (if available)
Genital warts (caused by certain types of HPV. Other HPV types cause abnormal cervical changes)	NIL	Warts may be round, flat or raised painless small, cauliflower-like bumps. They are generally flesh-colored, whitish pink to reddish brown, soft growths. Warts may be single or in clusters.	The client may present with a lump in vulva area before the wart actually appears. May spread to urethra, vagina, cervix, or anus area.	

Molluscum Contagiosum	NIL	Painless genital lesions that have a smooth waxy appearance often with a white central umbilication.	This is usually a benign condition, self-healing after a few weeks to months, with few complications.	
Other STI				
Name	Discharge	Erythema/Itching	Associated symptoms	Pictures (if available)
Pubic lice/crabs	NIL	Evident by excoriations or itchy small red maculopapules in pubic hair and surrounding area. Look for nits or lice attached to base of pubic hair.		

Chart adapted from Faculty of Primary Care Nurse Practitioner Program, Saskatchewan Institute of Applied Science and Technology (2000), Cervical Screening Initiatives Program of Newfoundland and Labrador (2001), & Laboratory Centre for Disease Control Expert Working Group on Canadian Guidelines for Sexually Transmitted Diseases (1998). All Graphics in this Section are from STD Clinical Slides from the Centers for Disease Control and Prevention, Division of STD Prevention & National Center for HIV/AIDS, Viral Hepatitis, STD, and TB Prevention (2013). Reprinted with permission.

Note: Signs and symptoms may overlap and may present differently in different clients. Some clients may have more than one infection at once, which is difficult to diagnosis clinically, so testing is important.

Suggested Readings

1. [Canadian STI Guidelines.](#)

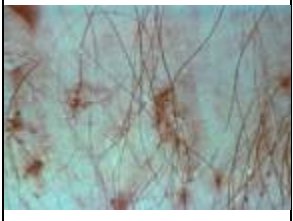
Section 7: Self-Test

1. Describe the phases of the menstrual cycle

2. Describe normal developmental changes associated with the female genitalia particularly for adolescents and older adults

3. Describe 10 aspects of female external and internal anatomy and physiology

4. Identify 5 abnormal findings and indications of STI, and when referral is necessary

5. Describe 3 variations of FGM

SECTION 8: EXTERNAL AND SPECULUM EXAM

Learning Objectives

Upon completion of this Section, the learner will be able to:

1. Describe how to perform a woman centered physical examination of the external genitalia.
2. Understand metal and disposable speculum functions.
3. Describe how to perform a woman centered speculum examination.
4. Identify which clients require referral to a Physician or Nurse Practitioner for Pap testing and/or follow-up.

Note: Part of this Section (Preparing the Client, External Exam, Clients with Special Considerations) are adapted from Faculty of Primary Care Nurse Practitioner Program, Saskatchewan Institute of Applied Science and Technology⁴⁴ and Calgary Health Region (2001).

Exam Equipment

Gather the following:

- Vaginal speculum of appropriate size (for more information on choosing a speculum, see Review of Speculums later in the chapter).
- Portable light or a light source with a disposable speculum.
- Gloves for a clean examination.
- Mirror (optional).

Ensure a new plastic speculum or a properly cleaned and autoclaved metal speculum is used to prevent transmission of infection or cross infection (e.g. HPV) to the client.

Preparing the Client

1. Introduce yourself to the client before she changes into a hospital gown.
2. Obtain a relevant health history as explained in **Section 6: Health History**.
3. Explain the physical assessment plan and validate it with the client.
4. Explain the procedural steps to the client and the reason for performing an external genital, speculum, and Pap test examination.
5. Explain the role of HPV testing in cervical cancer screening. Ensure she has a copy of the handout, “HPV Testing: Information for Women Having Pap Tests” that are provided in the trays of liquid-based supplies and are available [online](#).
6. Obtain verbal consent to proceed with the external examination, speculum exam and Pap test procedures.
7. Ask the client if she would like her support person to accompany her during the exam. Be sensitive to cultural diversity e.g. Muslim women may not want their male partner present.
8. To minimize discomfort while inserting the speculum, have the client void prior to the procedure.
9. Ensure maximum privacy.

10. Drape lower half of client's body. Since the gowns can be quite short, a drape placed over the client's abdomen to knees can add to her sense of privacy. This is especially true if she has a friend or chaperone present.
11. Assist the client into lithotomy position so that her body is supine. Place arms by side or across the chest, knees apart, and buttocks near the end of the examining table. Alternate positions such as stirrups for lithotomy position, M-shaped, or knee chest positions may also be used as explained below.

M-Shaped Position



In the M-shaped position the woman:

- Lies on her back, knees bent and apart.
- Feet resting on the examination table close to her buttocks.

The speculum must be inserted with the handle up. If the woman feels her legs are not completely stable on the examination table, an assistant may support her feet or knees.

The M-shaped position does not require the use of stirrups." If the woman tips her pelvis forward, the speculum may be inserted with the handle down, making the cervix easier to slip between the blades of the speculum.

Reprinted from Mosby's Guide to Physical Examination, Seidel et al., (2011) with permission from Elsevier.

Diamond-Shaped Position



In the diamond-shaped position the woman:

- Lies on her back with her knees bent.
- Both legs are spread flat and her heels meet at the front.

The speculum must be inserted with handle up. The diamond-shaped position does not require the use of stirrups.

Reprinted from Mosby's Guide to Physical Examination, Seidel et al., (2011) with permission from Elsevier.

Knee-Chest Position



In the Knee-Chest position, the woman:

- Lies on her side with both knees bent.
- With her top leg brought closer to her chest.

(A variation of this position would allow the woman to lie with her bottom leg straightened while the top leg is still bent close to her chest).

The speculum can be inserted with the handle pointed in the direction of the woman's abdomen or back. Because the woman is lying on her side, the RN should be sure to angle the speculum toward the small of the client's back and not straight up toward her head. An assistant may provide support for the client while she is on the examination table or help the woman straighten her bottom leg if she prefers the variation of this position. If the client cannot spread her legs, the assistant may help her elevate one leg. The knee-chest position does not require the use of stirrups. It is particularly good for a woman who feels most comfortable and balanced lying on her side. This position is helpful for elderly clients or physically disabled clients who have less range of motion.

Note: Most clinic rooms have the bed against the wall so the RN should approach the client from the right side and the client would be lying on the left side. It is also helpful to have the woman lie with her trunk across the exam bed at an angle of at least 45 degrees so it is easier for the RN to see the cervix.

Reprinted from Mosby's Guide to Physical Examination, Seidel et al., (2011) with permission from Elsevier.

Additional Recommendations

1. If the client wants to take an active part in the examination, elevate her head and shoulders to a semi-sitting position to maintain eye contact and provide the client with a mirror so that she can see what the RN is doing and has a full view of her genitalia.
2. Sit on a stool at the foot of the examining table.
3. Explain each step of the examination before it is done. Share your findings with the client throughout the examination. Be sure this is done in a supportive manner that the client won't misinterpret. Comments on what you are seeing that may not be relevant or are comparative to others may be harmful. Wait until after the examination to discuss abnormal findings further as this may cause anxiety.

External Examination

The external examination is a part of the well-woman's examination and the following steps may be selected according to client need, concerns, health history, and clinical setting. However, you may not be required to perform an external examination in certain clinical situations (e.g. a special Pap test clinic).

Check with your Employer's policies to determine if external examination is required.

The following information is an in depth description of the external exam and each step may not

need to be performed depending on the RNs assessment, the client’s needs, concerns, health history, and clinical setting.

Follow these steps:

1. Glove.
2. Warn the client that you are going to touch her thigh then the labia. Touch the inner thigh with the back of the hand before touching the genitals.
3. Separate the labia with the fingers of one hand.
4. Observe and/or examine the following AS NEEDED based on symptoms, history and clinical setting:

Assessing the Cervix	Note as Needed
<p>Inguinal and femoral lymph nodes Palpate as needed for enlarged nodes.</p>	
<p>Skin colour The skin should be smooth and clean.</p>	Sores, rashes, or lesions.
<p>Pubic hair</p>	Burrows of scabies, pubic lice nits.
<p>Labia majora May be gaping or closed, appear dry or moist, are usually symmetric, and may be atrophied or full. The tissue should feel soft and homogeneous.</p>	<p>Swelling, abrasion, rashes, or lesions, which suggest an infective or inflammatory process.</p> <p>If any of these signs are present, ask the client if she has been scratching.</p> <p>Observe for discoloration, varicosities, obvious scratching, or signs of trauma or scarring.</p> <p>Labial swelling, redness, or tenderness, particularly if unilateral, may be indicative of a Bartholin gland abscess.</p>
<p>Vaginal opening Can be a thin vertical slit or a large orifice with irregular edges from hymenal remnants. The tissue should be moist.</p>	Swelling, discoloration, lesions, fistulas, discharge, or fissures.
<p>Perineum Surface should be smooth; episiotomy scarring may be evident in clients who have borne children. The tissue will feel thick and smooth in the nulliparous clients. It will be thinner and rigid in multiparous clients.</p>	Tenderness, inflammation, fistulas, lesions, or growths.
<p>Anus Is more darkly pigmented, and the skin may appear coarse. If you touch the anus or perianal skin, be sure to change your gloves so that you do not introduce bacteria into the vagina during the speculum examination.</p>	Scarring, lesions, inflammation, fissures lumps, skin tags, or excoriation.



Speculum Exam Procedure

Refer pregnant clients to a Physician, Nurse Practitioner, or Registered Midwife if they are due for a Pap test and/or for prenatal care. Refer clients with a total or subtotal hysterectomy due to biopsy confirmed high-grade lesions or cervical cancer to their Physician or Nurse practitioner for follow-up. Women who have had a total hysterectomy for benign reasons (e.g. endometriosis) do not need to continue with Pap tests.

It is essential to become thoroughly familiar with how the speculum operates before beginning the examination as to not hurt the client.

- Become familiar with the operation of the **metal speculum** and the **disposable plastic speculum**. The mechanical action of each is somewhat different.
- Plastic specula typically make a loud click when locked or released. It is therefore important to forewarn the client about this click and avoid surprise and unnecessary anxiety.
- It is also helpful to note that the blades of the speculum are of slightly different lengths to more easily allow the cervix to “pop” in between them when positioned correctly.

Metal Speculum

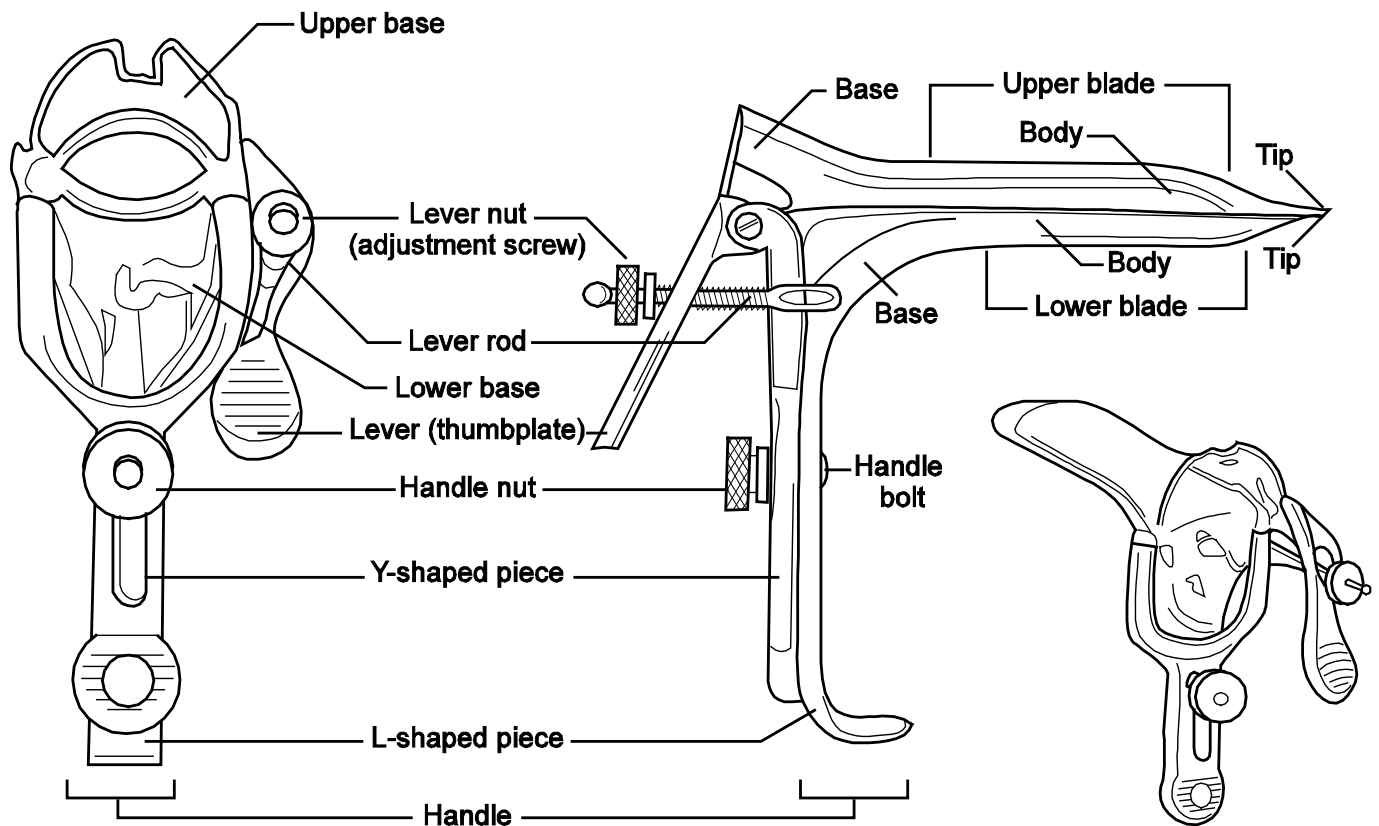

Disposable Speculum

Disposable Speculum

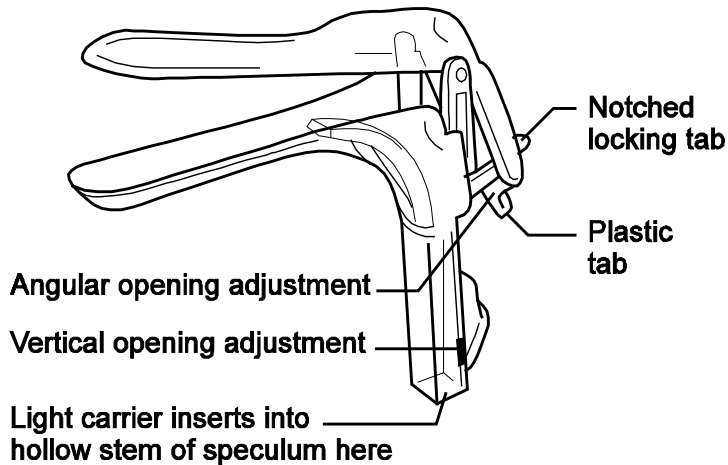

Light System

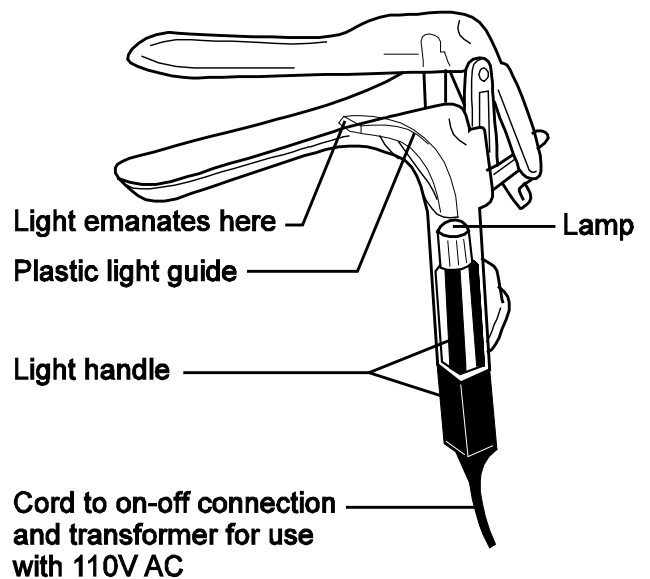

Locate a metal and disposable plastic speculum at your clinic/agency. Handle and review the parts of the speculums as per the above diagrams to understand how they function.

After taking the client's health history and examining her external genitalia, it is important to get an idea of the appropriate type and size of speculum needed. A smaller and narrower speculum may need to be used with clients who have not had vaginal penetration, nulliparous clients, clients who have undergone female genital mutilation, or clients whose vaginal introitus has contracted post-menopausally.

To begin the speculum exam:

1. Select the proper sized speculum.
2. Check the setscrews on a metal speculum.
 - Ensure the setscrew on the long handle (holding the two blades of the speculum together) is kept tightened.
 - Loosen the setscrew that holds the thumbscrew in place.
3. Lubricate the speculum with water. Water-soluble lubricant or jelly is NOT recommended due to a potential increase in unsatisfactory test results in both conventional and liquid-based cytology Pap tests.

As a client ages, her vaginal walls atrophy and therefore are drier than a younger client. Special attention to client comfort and lubrication should be a priority.

4. Warm the metal speculum by rinsing it in warm (not hot) water, holding it in your gloved hand or under the lamp for a few moments, or by having speculums on a warm heating pad

(test temperature against wrist before inserting). A cold speculum increases muscle tenseness.

5. Grasp the speculum with your dominant hand. The index and middle fingers should surround the blades and the thumb should rest against the back of the thumb rest to keep the tips of the blades closed.
6. Tell the client that she is going to feel you touching her. With the index and middle fingers of the other hand, open and push downward on the posterior fourchette. Ask the client to breathe slowly and try to consciously relax her muscles.
7. Place the blade tips against the lower (posterior) wall of the vagina to avoid contact with the urethra. Some RNs insert the speculum blades at an oblique angle: others prefer horizontal. In either case avoid touching the clitoris, catching pubic hair or pinching labial skin. Slowly insert the speculum maintaining gentle downward (toward posterior wall of vagina) pressure to avoid trauma to the urethra and vaginal walls.
8. Insert the closed speculum at the anatomic angle of the vagina (45° angle downward toward the small of the client's back).

Preparing to Insert Closed Speculum

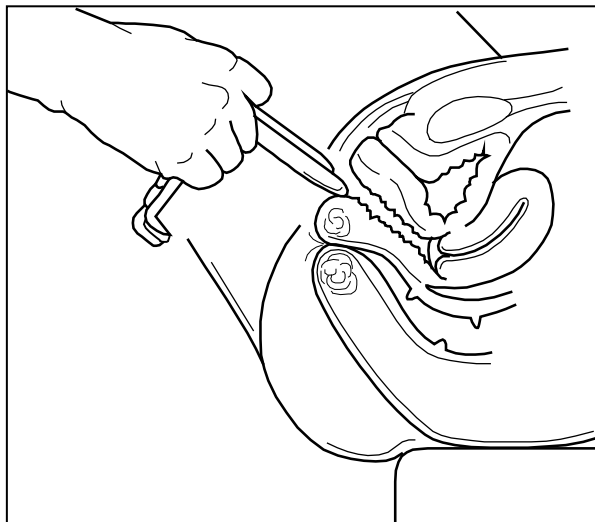

From Faculty of Primary Care Nurse Practitioner Program, Saskatchewan Institute of Applied Science and Technology (2000). Pap Testing and Bimanual Exam, p. 29. Reprinted with permission.

9. Insert the speculum further with gentle pressure downward. Continue to avoid pressure on the urethra and avoid catching pubic hair or pinching labial skin.

Inserting Closed Speculum

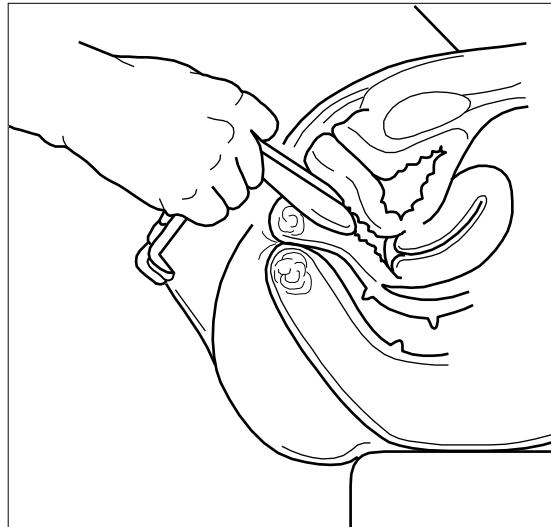

From Faculty of Primary Care Nurse Practitioner Program, Saskatchewan Institute of Applied Science and Technology (2000). Pap Testing and Bimanual Exam, p. 30. Reprinted with permission.

10. Insert the speculum up to the base of the cervix (the posterior fornix area) and then rotate it horizontally. Apply gentle pressure on the speculum against the perineum to help place the blade tips in the posterior fornix.
11. Remove the hand that has separated the labia.

Speculum Fully Inserted

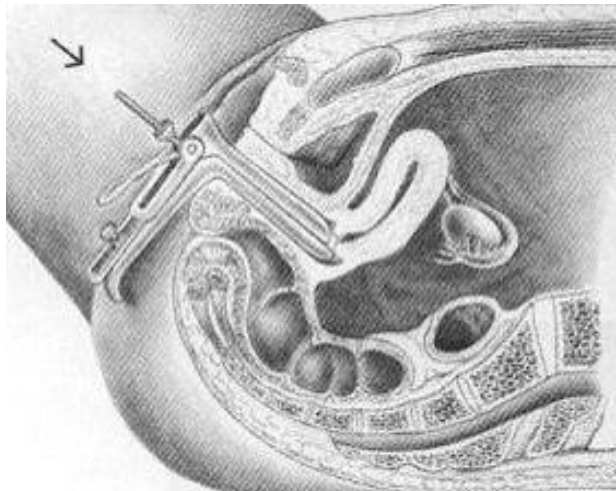

Reprinted from Mosby's Guide to Physical Examination, Seidel et al., (2011) with permission from Elsevier.

12. Maintaining downward pressure of the speculum, open it by pressing on the thumbpiece. Open the speculum as little as possible to see the cervix. Greater vaginal distension is unnecessary, and painful.
13. Move the speculum blades slowly upward until the cervix comes into view. Adjust the light source. Note: if the speculum is directed posteriorly on insertion, it is easier to find the

cervix and avoid a lot of unnecessary up and down movement of the speculum, which is uncomfortable for the client.

14. **If this attempt is unsuccessful:** Close the blade tips and withdraw the speculum slightly, then reinsert more deeply and posteriorly, with the base of the lower blade actually compressing the perineum. Then slowly move the blades upward again.
15. Once the cervix is central and clearly in view, tighten the lever nut of the **metal** speculum to lock the blade tips in the open position.

Speculum Open to View Cervix

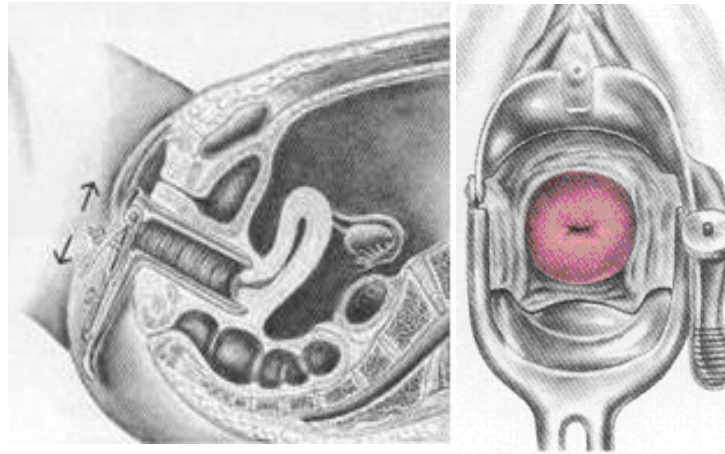

Reprinted from Mosby's Guide to Physical Examination, Seidel et al., (2011) with permission from Elsevier.

In most clients, the cervix has a posterior orientation that slightly obscures the cervix due to the vaginal walls. The cervix can be further obscured through a retroverted uterus, marked posterior orientation of the cervix, or laxity of the vaginal walls.

Client with Retroverted Uterus

A cervix that is pointing anteriorly indicates a retroverted uterus. The speculum has to be much further forward and RN may have to invert speculum to see the cervix.

Client with Posterior Orientation of the Cervix

Insert the speculum more deeply and posteriorly through compression of the perineal tissue. The blade tips will slip under the cervix into the posterior fornix.

Marked Posterior Orientation of the Cervix

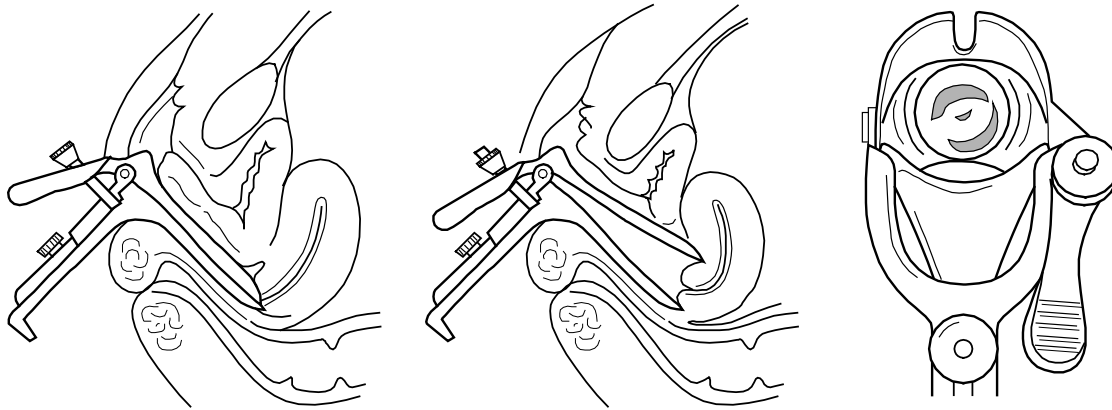

From Faculty of Primary Care Nurse Practitioner Program, Saskatchewan Institute of Applied Science and Technology (2000). Pap Testing and Bimanual Exam, p. 33. Reprinted with permission.

Client with Laxity of the Vaginal Walls

Inability to visualize the cervix due to laxity of vaginal walls may occur in some clients (e.g. obese clients). The blade base as well as the tips have to be opened when using a metal speculum. Unscrewing the handle nut in the metal speculum and pushing the Y-shaped piece upwards accomplish this. For the plastic speculum a larger size may be needed.

16. Inspect the cervix

Assessing the Cervix	Note as Needed	
Colour	<ul style="list-style-type: none"> • Pink, with the colour evenly distributed. • Bluish colour indicates increased vascularity that may be a sign of pregnancy. • Symmetric circumscribed erythema around the os is a normal finding that indicates exposed columnar epithelium from the cervical canal. • Beginning practitioners should consider any reddened areas as abnormal finding, especially if patchy or borders are irregular. • Pale cervix may indicate anemia or menopause. 	<ul style="list-style-type: none"> • Refer pregnant clients to a Physician, Nurse Practitioner, or Registered Midwife for Pap test and pre/postnatal follow up.
Position	<ul style="list-style-type: none"> • Correlates with the position of the uterus. A cervix that is pointing: <ul style="list-style-type: none"> ○ Anteriorly indicates a retroverted uterus. ○ Posteriorly indicates an anteverted uterus. ○ Horizontally indicates a uterus in midposition. 	<ul style="list-style-type: none"> • Deviation to the right or left may indicated a pelvic mass, uterine adhesions, or pregnancy. • Projection greater than 3 cm may indicate a pelvic or uterine mass.

Size	<ul style="list-style-type: none"> • Diameter ranges from 2 to 3 cm however, clients who have had multiple pregnancies may have larger diameters. 	<ul style="list-style-type: none"> • Enlarged cervix may indicate cervical infection.
Shape of Os	<ul style="list-style-type: none"> • Os of the nulliparous client is small, round, or oval. • The os of a multiparous client is usually a horizontal slit or may be irregular and stellate. • Trauma from induced abortion or difficult removal of an intrauterine device may change the shape of the os to a slit. 	<ul style="list-style-type: none"> • If the os is small and round; or horizontal irregular slit; or unilateral transverse slit or bilateral transverse slit; or stellate; or cervical eversion is present.
Surface	<ul style="list-style-type: none"> • Should be smooth. • Some squamocolumnar epithelium of the cervical canal may be visible as a symmetric reddened area around the os. • Nabothian cysts may be observed as small, white, or yellow, raised, round areas on the cervix and are considered to be a normal findings. 	<ul style="list-style-type: none"> • Refer to Physician or Nurse Practitioner immediately if you see any of the following: <ul style="list-style-type: none"> ○ Friable tissue (soft, eroded, may be bleeding), red patchy areas, abnormal bleeding, inflammation, granular areas, and white patches that could indicate infection, or carcinoma. ○ Swollen Nabothian cyst – becomes swollen with mucous and distorts the shape of the cervix, giving it an irregular appearance. ○ Polyps.
Secretions	<ul style="list-style-type: none"> • Determine whether the discharge comes from the cervix itself, or whether it is vaginal in origin and has been deposited in the cervix. • Normal discharge is odourless, may be creamy or white, may be thick, thin, or stringy, and is often heavier at midcycle or immediately before menstruation. 	<ul style="list-style-type: none"> • Abnormal vaginal discharge.

Remember that correct sampling technique increases the adequacy of the test sample and decreases the risk of a false-negative result.⁴⁴

It is estimated that at least one third or more of false-negative cytology tests (negative results when a woman has a high-grade cervical lesion) are related to sampling issues.

45

If there is a suspicion of malignancy (e.g. inflammation of the cervix, abnormal bleeding from cervix) the RN must refer to a physician or nurse practitioner for assessment and evaluation.

17. Perform Pap test (See [Section 9: Papanicolaou Test](#)).

18. Loosen the thumbscrew but continue to hold the speculum blades open.

19. Slowly withdraw the speculum, rotating it as you go to fully inspect the **vaginal wall**. The colour should be a similar pink colour as the cervix, or a little lighter. Clients with adequate estrogen levels have pink, moist, smooth or rugose and homogenous vaginal walls. Normal secretions that may be present are usually thin, clear or cloudy, and odourless.

Note as needed:

- Inflammation.
- Lesions.
- Swelling.
- Cracks.
- Abnormal discharge.
- Abnormal colour.
- Presence or absence of rugae.
- Reddened patches, lesions, or pallor indicates a local or systemic pathologic condition.
- Secretions that are profuse; thick, curdy, or frothy; appear gray, green, or yellow; and may have a foul odor indicate infection.

20. Close the blades when the end of the blades near the vaginal opening, making sure that no vaginal mucosa, skin, or hair remains between the closed blades. Maintain downward pressure of the speculum to avoid trauma to the urethra. Note the odor of any vaginal discharge that has pooled.

21. Turn the blades obliquely at a 45° angle and remove slowly from vagina.

22. Place the used metal speculum in a bucket or dispose of disposable speculum.

23. Discard your gloves and wash hands.

24. Inform the client that the procedure is over and that she can move into a seated position to discuss treatment and/or healthy behaviour goals. Alternatively, you could inform the client that you will leave for a minute while she gets dressed and that you will return to discuss treatment and/or healthy behaviour goals.

Complete External and Speculum Examination of the Genitalia: Summary Table

EXTERNAL EXAM	SPECULUM EXAM
<ul style="list-style-type: none">✓ Skin Colour✓ Pubic Hair✓ Labia Majora✓ Labia Minora✓ Urethra✓ Skene's Glands✓ Bartholin's Glands✓ Clitoris✓ Vaginal Opening✓ Perineum✓ Anus	<p>Cervix:</p> <ul style="list-style-type: none">✓ Colour✓ Position✓ Size✓ Shape of os✓ Surface✓ Secretions✓ Vaginal Wall

Consideration for Special Clients

Client with Hysterectomy

Getting an accurate history before the examination will assist you in knowing what to look for.

Refer clients with total or subtotal hysterectomy due to biopsy confirmed high-grade lesions or cervical cancer to their Physician or Nurse Practitioner for follow-up. Women who have had a hysterectomy for benign reasons (e.g. endometriosis) do not need to continue with Pap tests.

Older Adults

It is not appropriate to defer older clients from the external, speculum, and Pap test because of their age. See Discontinuing Screening in [Section 3: Cervical Screening Cycle](#). The examination procedure for the older adult is the same as that for the adult of childbearing age, with a few modifications for comfort. The older client may require:

- More time and assistance to assume the lithotomy position.
- Assistance from another individual to help hold her legs, since they may tire easily when the hip joints remain in abduction for an extended period.
- Head and chest elevated during examination if she has orthopnea.
- Use of a smaller speculum depending on the degree of introital constriction that occurs with aging.

Note that, in comparison to a younger adult, the older adult's:

- Labia appear flatter and smaller, corresponding with decreased levels of estrogen and/or degree of loss of subcutaneous fat elsewhere on the body.
- Skin is drier and shinier.
- Pubic hair is gray and may be sparse.



- Clitoris is smaller.
- Urinary meatus may appear as an irregular opening or slit. It may be located more posteriorly, very near, or within the vaginal introitus as a result of relaxed perineal musculature.
- Vaginal introitus may be constricted and admit only one finger. In some multiparous older clients the introitus may gape with the vaginal walls rolling toward the opening.
- Vagina is narrower and shorter, and you will see and feel the absence of rugation.
- Cervix is smaller and paler, and the surrounding fornices may be smaller or absent. The cervix may seem less mobile if it protrudes less far into the vaginal canal. The os may be smaller, but, should still be palpable, (if the os is very small and/or closed over, it may be impossible to insert a cytobrush/spatula or broom into the os. After 2 attempts, the RN will need to refer the client to a Physician or Nurse Practitioner).
- Pelvic musculature relaxes, so remember to look particularly for stress incontinence and prolapse of the vaginal walls or uterus.

As with younger clients, there may be signs of inflammation (older clients are particularly susceptible to atrophic vaginitis), infection, trauma, tenderness, growth, masses, nodules, enlargement, irregularity, and changes in consistency. Any concerns should be referred to a Physician or Nurse Practitioner.

When to Refer a Client

Clients should be referred to a Physician or Nurse Practitioner when their circumstances are outside the scope of the RN's training. The following table outlines scenarios in which the client should be referred. Keep in mind that the list is not inclusive of all scenarios that require referral.

DO NOT SCREEN:

Clients with any of the following should be referred to a primary care provider and the RN should NOT proceed with the Pap test.

- Pregnancy, only if client is due for screening.
- Previous diagnosis of cervical cancer.
- Symptomatic patients:
 - Unusual bleeding or discharge
- Visual abnormality.
- Clients under the age of 21.
- Clients under the age of 25 should not be screened unless they are at high risk (e.g. early sexual debut, multiple partners, immunosuppressed, etc.)
- Biopsy confirmed high-grade squamous intraepithelial lesions (HSIL), adenocarcinoma in situ (AIS), or invasive cervical cancer.
- Immunocompromised (e.g. HIV/AIDS) and/or those taking long term oral immunosuppressant medications.
- Total or subtotal hysterectomy due to biopsy confirmed high grade lesions or cervical cancer.

Section 8: Self-Test

1. Describe the parts and functioning of both the metal and plastic disposable speculums

2. Describe four areas to examine during the external genital exam

3. Which clients would RNs refer to a Physician, Nurse Practitioner, (or Registered Midwife) for Pap test and/or follow-up?

4. List the steps to follow to properly insert the speculum.

5. Describe four areas to examine for the internal genital exam.

6. What are two ways an older adult's normal external and internal genitalia may appear different in comparison to a younger adult?

SECTION 9: PAPANICOLAOU TEST

Learning Objectives

Upon completion of this Section, the learner will be able to:

1. Identify ideal conditions for taking Pap tests.
2. Describe how to perform a woman-centered Pap test.
3. Understand how to accurately label & prepare a Pap test slide OR cytology container and complete a cytopathology laboratory requisition form.

Ideal Conditions for Taking Pap Tests

- Avoidance of vaginal douching for 24 hours before the test.
- Avoidance of use of contraceptive creams or jellies for 24 hours before the test.
- Avoidance of intercourse for 24 hours before the test.
- Pap tests are not recommended during menstruation as it increases the chance of inadequate or unsatisfactory sample results. A mid-cycle test is optimum. All abnormal bleeding should be assessed and evaluated by a physician or nurse practitioner.

Sampling Areas

The three sampling areas of the cervix are the ectocervix, the endocervix, and the transformation zone. The cervical lining is made up of two types of cells: rectangular columnar cells and flatter squamous cells. The area between these cell types is called the transformation zone (or squamo-columnar junction) because this is where columnar cells change into squamous cells. Due to the cell changes happening in the transformation zone, it is the most common area for abnormal squamous cells to develop.

The transformation zone is therefore the primary target for sampling of the cervix by the Pap test technique. Good Pap test sampling shows cells from each side of the squamo-columnar junction. This requires choosing the right instrument or parts of the instrument to ensure that it is firmly applied across the area. The spatula, brush, and broom are more important at different ages to gain good samples.

The location of the transformation zone varies from woman to woman and changes as women age. In young women, the transformation zone tends to be on the outer surface of the cervix (ectocervix) whereas it tends to be higher up in the cervical canal in older women.

See illustrations under *Transformation Zone* in [Section 7: Physiology, Anatomy & Abnormal Findings](#) and below under *Sampling the Ectocervix with the Spatula*.

Liquid Based Cytology Collection Instructions

Traditionally, the conventional Pap test sample was collected using a wooden spatula and brush, smeared on to a glass slide and fixed. Alberta now offers liquid-based cytology (LBC). Two different LBC products are available in Alberta; ThinPrep and SurePath™. After the sample is collected, the brush/spatula are either swished (ThinPrep) or the brush/spatula or

broom are broken off and dropped into a small container (SurePath™) of preservative liquid before being transported to the lab. The sample is spun at the lab to remove obscuring materials and a representative sample is spread on a slide for examination under a microscope.

This technology offers several advantages over conventional Pap testing:

1. Immediate preservation of collected cells
2. Entire sample is recovered rather than lost with the discarded spatula/brush/broom.
3. Preservative contains chemicals that lyse blood, mucus and inflammatory cells allowing for a clean specimen and easier identification of abnormal cells.
4. Multiple slides can be prepared.
5. Additional tests such as HPV reflex testing can be performed on the same sample.

Consult LBC Manufacturer's Instructions depending on the type of LBC used in your clinic/agency.

- Alberta Public Laboratories: Thin Prep Guide
<https://www.albertahealthservices.ca/assets/wf/lab/if-lab-tc-thinprep-gynecological-pap-specimen-collection-quick-reference-guide.pdf>
- DynaLIFE: Health Professionals BD SurePath™ Collection Instructions
<https://www.dynalife.ca/Portals/0/pdf/Health%20Professionals/BD%20SurePath%20collection%20instructions.pdf>



Equipment for Pap Test

- Vaginal speculum of appropriate size
- Portable light or a light source with a disposable speculum
- Gloves, clean examination
- Cotton tipped swab (optional)
- Mirror (optional)
- Lab requisition and specimen label
- Pencil or pen
- Plastic spatula and cytobrush or;
- Broom
- LBC specimen container
- Information Sheet: HPV Testing Information for Women Having Pap Tests (available from <https://screeningforlife.ca/wp-content/uploads/2019/12/ACCSP-Info-Sheet-HPV-Testing-Information-for-Women-Having-Pap-Tests-Nov-2011.pdf>)

Ensure a new plastic speculum or a properly cleaned and autoclaved metal speculum is used to prevent transmission of infection or cross infection (e.g. HPV) to the client.

Pap Test Procedure

This following information is adapted from the Faculty of Primary Care Nurse Practitioner Program, Saskatchewan Institute of Applied Science and Technology⁴⁴ and Calgary Health Region (2001).



1. Prepare the client as explained in the Speculum Exam Procedure, [Section 8: External & Speculum Exam](#).
2. In an understanding and non-judgmental way, explain the purpose of the Pap test, the role of HPV reflex testing, the instruments to be used, the procedure, possible test results and follow-up and the recommended frequency of Pap tests. Give each client written information on Pap tests as indicated and a copy of the handout, “HPV Testing Information for Women Having Pap Tests” provided with each tray of LBC vials.
3. Assemble necessary equipment. For sample collection, either a spatula and cytobrush, or broom can be used.
4. Label the Pap Test Container according to your clinic/agency lab requirements.
5. Open the Pap Test Container and place in a secure and accessible place near the examination bed.
6. Consult LBC Manufacturer’s Instructions depending on type of LBC used in your clinic/agency.
7. Inspect the client's external genitalia as explained in [Section 8: External & Speculum Exam](#).
8. Warm and insert an appropriately sized speculum and inspect the cervix as explained in [Section 8: External & Speculum Exam](#).
9. Gently wipe away excessive discharge/mucous on the cervix with an oversized cotton swab or 2 x 2” gauze on a long forcep.⁴⁶ This should be done as gently as possible to avoid removing the cervical cells to be sampled.

Sampling the Ectocervix with the Spatula

1. Assess position of transformation zone (T-zone) to ensure zone will be sampled.
 - To identify the T-Zone look for the colour change between the red columnar epithelium and the smooth pink mature squamous epithelium and be sure to sample this area.
 - The diagrams below show sampling of different cervixes with the spatula. The solid grey area is the squamous epithelium, the lined area is the transformation zone and the stippled area is the columnar epithelium.

The spatula in the illustration is shaped slightly different from the spatulas more commonly used in Alberta. Spatulas that do not completely sample from the T-Zone necessitate the use of a cytobrush sample as well as the spatula sample.

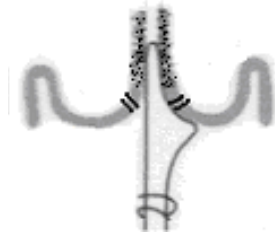

A: Narrow transformation zone

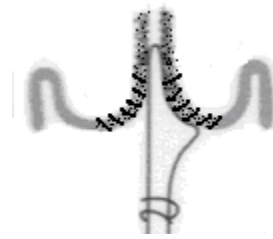

B: Broader transformation zone – parous

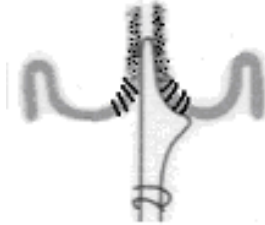

C: Broadly everted transformation zone – parous

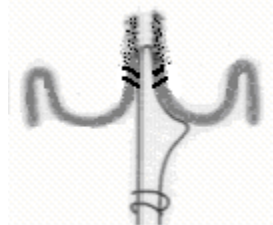

D: Post-menopausal (indrawn)

From Alberta Cervical Cancer Screening Program (2002). *Cervical Cancer Screening: Quick Reference Card*. Adapted with permission.

- Using the spatula, insert the bifid end (i.e. the spatula end with two bumps on it) with the more extended bump going into the cervical os so that the spatula is horizontal at the 3 and 9 o'clock position.
- Use firm pressure and rotate the spatula **360°** ending back at your starting point in order to ensure that you have scraped along the entire T-zone. Care is required to follow the shape of the os especially if it is irregular or elongated.
- Withdraw the spatula carefully to avoid contamination with the vaginal walls.
- Retain the sample on the front side of the spatula during transfer.
- Collect sample according to LBC Manufacturer's Instructions depending on type of LBC used in your clinic/agency.
 - [Alberta Public Laboratories: ThinPrep Guide](#) OR
 - [DynaLife: SurePath Guide](#)

Sampling the Endocervix with the Cytobrush

Because bleeding may result from using a cytobrush, the endocervix sample is taken after the ectocervix sample.²⁶

- The brush should be inserted into the endocervical canal if possible to the full depth of the brush, so the last bristles are just visible.
- Rotate it 90 degrees only. Over-rotating may damage some cervical cells, and often induces more capillary bleeding which may increase post Pap spotting and temporarily increase the risk of STI.
- Remove the cytobrush carefully to avoid contamination by vaginal walls.

10. Collect sample according to LBC Manufacturer's Instructions depending on type of LBC used in your clinic/agency.
 - a. [Alberta Public Laboratories: ThinPrep Guide](#) OR
 - b. [DynaLife: SurePath Guide](#)

Cytobrush in Endocervix

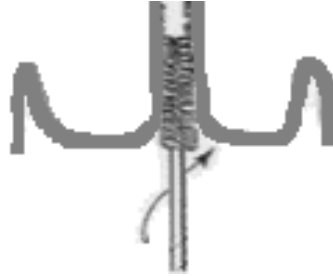

From Alberta Cervical Cancer Screening Program (2002). Cervical Cancer Screening: Quick Reference Card. Adapted with permission.

Sampling the Endocervix and Ectocervix with the broom type Cervex Brush

The broom can sample both the endocervix and the ectocervix at the same time, and does not require the additional use of the spatula or cytobrush.

1. Insert the extended bristles of the broom into the endocervical canal, until the lateral bristles spread out over the ectocervix.
2. Using consistent, gentle pressure, rotate the broom 5 times clockwise. Do this by rotating the shaft of the brush between your thumb and forefinger.
3. Remove the broom carefully to avoid contamination by vaginal walls.
5. Collect sample according to LBC Manufacturer's Instructions depending on type of LBC used in your clinic/agency.
 - [DynaLife: SurePath Guide](#)
 - [Instructional video](#) from DynaLife

After taking the sample

1. Slowly withdraw the speculum as explained in [Section 8: External and Speculum Exam](#).
2. Place speculum in bucket.
3. Discard gloves and wash hands.
4. Inform the client that she may have bloody spotting following the procedure and offer the client a panty-liner.
5. Inform the client that the procedure is over and that she can move into a seated position as explained in [Section 8: External and Speculum Exam](#).

6. Explain to the client how she will be contacted with her results and how follow-up may be arranged with her Physician or Nurse Practitioner if her Pap test is abnormal.
7. Ensure that the client understands her future appointment times and dates and understands the importance of follow up of abnormal Pap results with her Physician or Nurse Practitioner before she leaves the clinic. If necessary, indicate on written material when to schedule her next Pap test.
8. Discuss and provide client with written information (see ACCSP brochures at https://screeningforlife.ca/order-resources/?type_of_screening='Cervical').
9. Offer her information about the ACCSP and explain that she will get a result letter from the ACCSP within 3-6 weeks after her test. Let her know she can call the program's toll-free number (1-866-727-3926) or visit https://screeningforlife.ca/about-us-2/#participation_options if she is not sure she wants to receive a result letter.
10. Complete requisition and prepare slide or container for transport to your regional Laboratory Services.
11. Make arrangements for the sample to be sent to the laboratory.

Pap Test Sample: Submission Procedures

Healthcare Provider Setup Request Form for Labs

Once cervical cancer screening is part of their professional practice; RNs will be required to submit a Healthcare Provider Setup Request Form to the lab service in their area. This form **must** be sent in prior to submitting samples to the lab. When filling out the form, **RNs will be required to input their CARNA identification numbers**. The PRAC ID field should be left blank. Examples of completed forms can be found below. Areas highlighted in yellow are of note.



Alberta Public Laboratories Healthcare Provider Information Form:

<https://www.albertahealthservices.ca/assets/wf/lab/wf-lab-frm-cal-csd2708.docx>

For more information about setting up laboratory services with APL, including ordering laboratory supplies and setting up electronic reporting, please visit the Client Services Information webpage:

<https://www.albertaprecisionlabs.ca/hp/Page13842.aspx>

DynaLIFE Healthcare Provider Setup Request Form:

<https://www.dynalife.ca/Portals/0/pdf/Pharmacists%20info/Attachment%20A%20Laboratory%20Information%20System%20Setup%20Request%20Form%20v2.pdf>

For more information about setting up laboratory services with DynaLIFE, including ordering laboratory supplies please visit the Setting up Laboratory Services webpage:

<https://www.dynalife.ca/SettingUpLaboratoryServices>

Sample Alberta Public Laboratories Healthcare Provider Information Form



Health Care Provider Information

Email completed form to APL_DataIntegrityPhysBuild@albertaprecisionlabs.ca or fax to APL Data Integrity at 403-770-3235.

IMPORTANT: It is your responsibility to keep this information current. Email or fax any changes as soon as possible.

Request Date: 2021-06-01
YYYY-MM-DD

Effective Date: 2021-07-01
YYYY-MM-DD

<input checked="" type="checkbox"/> New Physician Location	<input type="checkbox"/> Office Relocation <small>(All patient files relocated with physician)</small>	<input type="checkbox"/> Physician Practice/Office Closure <small>www.calgarylabservices.com for APL form # CSD2709</small>
---	--	---

Health Care Provider Name	(Last) Smith	(First) Carna	(Middle) L
Prac ID #	Registered Nurse CARNA # 00000		
<input type="checkbox"/> Physician (MD) List speciality:		<input type="checkbox"/> Podiatric Surgeon (DPM)	<input type="checkbox"/> Nurse Practitioner (NP)
<input type="checkbox"/> Dentist (DMD)		<input type="checkbox"/> Pharmacist (RPh)	<input type="checkbox"/> Chiropractor (DC)
<input type="checkbox"/> Physiotherapist		<input type="checkbox"/> Optometrist (OD)	<input checked="" type="checkbox"/> Other: RN
Building Name/Clinic Name	Central Pap Test Clinic		
Is this a home office?	<input type="checkbox"/> Yes <input checked="" type="checkbox"/> No		
Address	Suite 123, 123 Pap Test Lane		
City, Province, Postal Code	Cervical City, Alberta, T0T 0T0		
Office Phone	555-011-2233		
Office Secure Fax Number	none		
Email Address	CarnaSmith@centralpaptestclinic.com		
After Hours Contact Information – required as per CPSA Health Professionals Act Standards of Practice IMPORTANT: a minimum of one after hours contact number is mandatory			
Answering Service Number			
Pager/Cell Phone Number	555-123-4567		
Home Phone Number			
Report Distribution – Select one method of laboratory report distribution:			
<input checked="" type="checkbox"/> Electronic Delivery to your EMR	Facility ID:	EMR Vendor:	
<input type="checkbox"/> ER4 Delivery Access Number:			
<input type="checkbox"/> Fax			

Authorized Signature	<i>C. Smith</i>	Title	Registered Nurse	Date	2021-06-01
-----------------------------	-----------------	--------------	------------------	-------------	------------

For Lab Use Only
Organization/Facility Number: _____ Provider Number: _____ Route Stop ID: _____

Sample DynaLIFE Healthcare Provider Setup Request Form



HEALTHCARE PROVIDER SETUP REQUEST FORM

Email completed form to DL Data Entry Editors @ Copath.editors@dynaLIFE.ca or Fax to 780-701-1721.

IMPORTANT: It is your responsibility to keep this information current. E-mail or fax changes as soon as possible.

DATE: August 1, 2019

<input checked="" type="checkbox"/> NEW PHYSICIAN	<input type="checkbox"/> OFFICE RELOCATION <small>(All patient files relocated with physician)</small>	<input type="checkbox"/> PHYSICIAN PRACTICE/OFFICE CLOSURE
--	--	---

HEALTHCARE PROVIDER	(Last)	(First)	(Middle)
NAME:	<u>Smith</u>	<u>Carna</u>	<u>Lynn</u>
Practitioner ID (9 digit #):	CARNA (5 digit #): <u>00000</u>		
<input type="checkbox"/> Physician	<input type="checkbox"/> Pharmacist	<input type="checkbox"/> Optometrist	<input checked="" type="checkbox"/> Registered Nurse (RN)
		<input type="checkbox"/> Nurse Practitioner (NP)	<input type="checkbox"/> Midwife (MW)

AFTER HOURS CONTACT INFORMATION – REQUIRED AS PER CPSA HEALTH PROFESSIONALS ACT STANDARDS OF PRACTICE

IMPORTANT: A MINIMUM OF ONE AFTER HOURS CONTACT NUMBER IS MANDATORY.

Phone Number 1: 403-012-3456 Cell Home Pager
 Phone Number 2: _____ Cell Home Pager

NEW LOCATION:- ONLY ONE FORM PER LOCATION IS REQUIRED FOR SET-UP (FOR ADDITIONAL HEALTHCARE PROVIDERS COMPLETE PAGE 2)

Building Name: Central Pap Test Clinic Clinic/Pharmacy Name: same
 Address: Suite 123, 123 Pap Test Lane
 City, Prov, Postal Code: Cervical City, Alberta, T0T0T0
 Phone: 780-012-3456 Secure Fax: none Email: carnasmithe@centralpaptestclinic.com
 Hours & Days of Operation: Monday - Friday, 8:30a.m. - 5:30p.m.
 Effective Date: September 1, 2019 Requester Name and Phone: Carna Smith 780-012-3456

EXISTING LOCATION / RELOCATION IS EXISTING LOCATION CLOSING? Yes No

Building/Clinic Name: _____ Location Code: _____
 Address: _____
 City, Prov, Postal Code: _____
 Phone: _____ Secure Fax: _____ Email: _____

SPECIMEN COLLECTION INFORMATION (FOR NEW LOCATIONS ONLY):

Supplies Required: Requisitions Only Specimen Collection Supplies
 Do you typically collect specimens (swabs, paps, biopsies ?): No Yes (if yes please indicate days below)
 Mon Tues Wed Thurs Fri Sat Sun

DL EDITORS NOTIFICATION

Banner Sheet: _____ Method of Result Delivery: _____
 Physician Code: _____ Location Code: _____
 Maintenance performed by: _____ NARP Sent: _____
 Maintenance Completed Date: _____ Notification date: _____

Cytopathology Lab Requisition Forms

To ensure that all Pap test specimens receive an optimal evaluation, it is critical that accurate clinical information is communicated to the cytology laboratory.

Locate the cytopathology laboratory requisition form used by your clinic/agency and become familiar with the specific clinical information that you are required to document. If the client has consented, whenever possible, you should copy a report to the client's Primary Care Physician.

HPV tests are not ordered with screening Pap tests per se. They are done on a reflex basis by the lab on residual liquid-based samples depending on a woman's age and cytology result.

Alberta Public Laboratories Gynecological Cytopathology Requisition:

<https://www.albertahealthservices.ca/assets/wf/lab/if-lab-hp-cal-req9043cy-gyn.pdf>

DynaLIFE Gynecologic Cytopathology Requisition: <https://www.dynalife.ca/requisitions>

You will need to enter your provider information in order to download the requisition form.

For assistance in completing the requisition forms, please see the Requisition Completion Aids:

DynaLIFE Requisition Completion Aid:

https://www.dynalife.ca/Portals/0/pdf/Requisitions/Gyne_Reg_Leader_Sheet.pdf

APL Requisition Completion Aid:

<https://www.albertahealthservices.ca/assets/wf/lab/wf-lab-hp-cal-csd2722.pdf>

Specimen Handling, Transport and Labelling

Ensure that packaging is in accordance with your lab's specific packaging and transport requirements.

Alberta Public Laboratories: Sample Label Requirements [https://www.albertaprecisionlabs.ca/tc/Page13874.aspx#:~:text=The%20label%20must%20include%2C%20at,Medical%20Record%20Number%20\(MRN\).](https://www.albertaprecisionlabs.ca/tc/Page13874.aspx#:~:text=The%20label%20must%20include%2C%20at,Medical%20Record%20Number%20(MRN).)

DynaLIFE: Health Professionals Specimen Submission Criteria

<https://www.dynalife.ca/Portals/0/pdf/Health%20Professionals/Specimen%20Submission%20Criteria.pdf>

Recommended Readings

1. Alberta Public Laboratories: Thin Prep Guide
<https://www.albertahealthservices.ca/assets/wf/lab/if-lab-tc-thinprep-gynecological-pap-specimen-collection-quick-reference-guide.pdf>
2. DynaLIFE: Health Professionals BD SurePath™ Collection Instructions
<https://www.dynalife.ca/Portals/0/pdf/Health%20Professionals/BD%20SurePath%20collection%20instructions.pdf>

Section 9: Self-Test

1. Name 4 ideal conditions for taking a Pap test.
2. How do you sample the ectocervix with a spatula?
3. How do you sample the endocervix with a brush?
4. How do you sample the ectocervix and endocervix with a broom?
5. How do you prepare the Liquid Based Cytology specimen container?

SECTION 10: PAP TEST RESULTS

Learning Objectives

Upon completion of this Section, the learner will be able to:

1. Identify how Pap test results are interpreted and the reasons for unsatisfactory and abnormal results.
2. Describe the appropriate follow-up for each Pap result using the TOP (2016) Management of Abnormal Cytology chart.
3. List groups with special circumstances for the follow-up and management of abnormal Pap tests.

Note: This Section is adapted from the *Guideline for Screening for Cervical Cancer*¹ (p. 3-5, 10-14). Used with permission.

The Bethesda System

The Bethesda system for reporting Pap tests⁴⁷ is the recommended standard for use in Canada and by the Alberta Cervical Cancer Screening Program. Reports include a statement of adequacy and the diagnosis. There are two categories of specimen adequacy, “Satisfactory for Evaluation” and “Unsatisfactory for Evaluation.”

Unsatisfactory Pap Test Results

Unsatisfactory for evaluation indicates the test was rejected/not processed or that the specimen was processed and examined but was unsatisfactory for evaluation of epithelial abnormality. The reasons the test was considered unsatisfactory are given in the report (e.g. too few cells were collected).

Unsatisfactory Pap test results are mostly due to cervical sampling and specimen collection issues.

Possible reasons for unsatisfactory Pap tests include:

Client Reasons

- Intercourse within 24 hours of Pap test
- Douching or vaginal medication used 24 hours before Pap test
- Menses
- Body habitus (obesity may make the procedure more difficult)

Provider Reasons

- Did not sample far enough into endocervical canal to obtain endocervical/metaplastic cells.
- Did not follow manufacturer’s instructions for transferring the sample from the instrument to the liquid medium.
- Lack of cellular exfoliation (instrument choice).
- Lack of clinical information obtained.

(Adapted from SIAST, 2000).



Abnormal Pap Test Results

The Bethesda⁴⁸ diagnostic categories are as follows:

Negative for Intraepithelial Lesion (NIL) or Malignancy (NILM)

- Pap tests interpreted as Negative for Intraepithelial Lesion or Malignancy indicate that the test was satisfactory and that the woman should continue with routine screening.

Epithelial Cell Abnormality

- Pap tests interpreted as Epithelial Cell Abnormality include **both those that represent cervical carcinoma and those that have changes considered to indicate increased risk of cervical carcinoma.**
- Changes indicative of increased risk for cervical carcinoma are reported as follows:
 - Atypical Squamous Cells of Undetermined Significance (ASC-US)
 - Low-Grade Squamous Intraepithelial Lesion (LSIL)
 - Atypical Squamous Cells – cannot exclude HSIL (ASC-H)
 - High-Grade Squamous Intraepithelial Lesion (HSIL)
 - Atypical Glandular Cells (AGC)
 - Adenocarcinoma in Situ (AIS)

Follow up of Normal and Abnormal Results	
Pap Test Result	Recommended Management
Negative for Intraepithelial lesion or malignancy (NILM)	Return to routine screening.
Unsatisfactory (Unsat)	Repeat Pap test but not before three months.
Atypical squamous cells of undetermined significance (ASC-US)	Clients < 24 years (Although routine screening is NOT recommended)
	Repeat Pap test every 12 months for two years (two tests): <ul style="list-style-type: none"> - At 12 months: ONLY high grade lesions refer to colposcopy.* - At 24 months: <ul style="list-style-type: none"> - Negative → return to routine screening. - ASC-US or greater → refer for colposcopy.*
	Clients 25-29 years
	Repeat Pap test every six months for one year (two tests). These tests must be at least six months apart. <ul style="list-style-type: none"> - If both repeat test results are negative → follow up is routine screening (every three years). - If either repeat result is ASC-US or greater → refer for colposcopy.*
	Clients ≥ 30 years (the lab will automatically perform HPV reflex testing)
	<ul style="list-style-type: none"> - HPV Negative → risk equivalent to NILM. Follow-up is routine screening. - HPV Positive → refer to colposcopy.* - HPV Indeterminate → manage as per lab instructions.*
Low-grade squamous intraepithelial lesions (LSIL)	Clients < 24 years (Although routine screening is NOT recommended)
	Repeat Pap test every 12 months for two years (two tests): <ul style="list-style-type: none"> - At 12 months: Only high grade lesions refer to colposcopy.* - At 24 months: <ul style="list-style-type: none"> - Negative → follow up is routine screening. - ASC-US or greater → refer to colposcopy.*



Low-grade squamous intraepithelial lesions (LSIL)	Clients 25-49 years
	Repeat Pap test every six months for one year (two tests). These tests must be at least six months apart. <ul style="list-style-type: none"> - If both repeat test results are negative → follow up is routine screening (every three years). If either repeat result is ASC-US or greater → refer for colposcopy.*
	Clients ≥ 50 years (the lab will automatically perform HPV reflex testing)
	<ul style="list-style-type: none"> - HPV Negative → risk level is equivalent to NILM. Follow up is routine screening. - HPV Positive → refer to colposcopy.* - HPV Indeterminate → manage as per lab instructions.*
High-grade squamous intraepithelial lesions (HSIL)	Refer all ages to colposcopy.
Atypical squamous cells – cannot exclude HSIL (ASC-H)	
Atypical glandular cells (AGC)	
Adenocarcinoma in situ (AIS)	
Squamous carcinoma, other malignancy	Refer all ages to specialist.
<p>*Ensure Care Coordination: Appropriate mechanisms should be established to ensure timely referral to the primary care provider, nurse practitioner or colposcopist/specialist.</p>	



Management of Abnormal Pap Test Results ([download](#))

MANAGEMENT OF ABNORMAL PAP TEST RESULT			
Return to routine screening: Patient returns to three-year interval Pap testing and is defined as from the date of the last NILM [negative for intraepithelial lesion or malignancy] specimen regardless of age and/or any previous testing interval.			
Unsatisfactory: Repeat Pap but not before three months.			
Transformational zone absent (SNTZ) is a lab code (now modified): Absence of endocervical glandular cells/transformation zone component. <i>Specimen still considered satisfactory for evaluation and does not require repeat.</i>			
Atypical squamous cells of undetermined significance(ASC-US)			
Patients ≤24 years: If screened, with ASC-US result, repeat Pap test every 12 months for two years (two tests):			
<ul style="list-style-type: none"> At 12 months: ONLY high-grade lesions refer for colposcopy. At 24 months: Negative → return to routine screening. ASC-US or greater → refer for colposcopy no later than three years after initial ASC-US result date; otherwise Pap test must be repeated. 			
Patients 25-29 years: Repeat Pap test every six months for one year (two tests). These tests must be at least six months apart.			
<ul style="list-style-type: none"> If both repeat results are negative → follow up is routine screening (every three years). If either repeat result is ASC-US or greater → refer for colposcopy no later than three years after initial ASC-US result date; otherwise Pap test must be repeated. 			
Patients ≥ 30 years: (<i>The lab will automatically perform HPV reflex testing</i>)			
<ul style="list-style-type: none"> HPV Negative* → risk level equivalent to NILM. Follow-up is routine screening HPV Positive → refer for colposcopy no later than three years after initial ASCUS result date; otherwise Pap test must be repeated. HPV Indeterminate → manage as per lab instructions. 			
Low-grade squamous intraepithelial lesion (LSIL)			
Patients ≤24 years: If screened with LSIL result: Repeat Pap test every 12 months for two years (two tests):			
<ul style="list-style-type: none"> At 12 months: ONLY high-grade lesions refer for colposcopy At 24 months: Negative → follow up is routine screening ASC-US or greater → refer for colposcopy no later than three years after initial LSIL result date; otherwise Pap test must be repeated. 			
Patients 25-49 years: Repeat Pap test every six months for one year (two tests). These tests must be at least six months apart.			
<ul style="list-style-type: none"> If both repeat results are negative → follow up is routine screening. If any either repeat is ASC-US or greater → refer for colposcopy no later than three years after initial LSIL result date; otherwise Pap test must be repeated. 			
Patients ≥50 years: (<i>The lab will automatically perform HPV reflex testing</i>)			
<ul style="list-style-type: none"> HPV Negative* → risk level is equivalent to NILM. Follow-up is routine screening. HPV Positive → refer for colposcopy no later than three years after initial LSIL result date; otherwise Pap test must be repeated. HPV Indeterminate → manage as per lab instructions. 			
*The risk of CIN3+ over three years is virtually the same for HPV negative patients as for patients with negative cytology in the absence of HPV testing.			
High-grade squamous intraepithelial lesion (HSIL)	ASC-H	Atypical glandular cells (AGC), adenocarcinoma in situ	Squamous carcinoma, adenocarcinoma, other malignancy
Refer all ages for colposcopy.			Refer all ages to specialist
Patients with cytologically benign endometrial cells			
Endometrial sampling is required if there is abnormal bleeding, the woman is asymptomatic and post-menopausal. Also consider endometrial sampling if the woman is asymptomatic, pre-menopausal and at increased risk for endometrial cancer due to chronic unopposed estrogen stimulation.			

Table 6: Management of Abnormal Pap Test Result¹



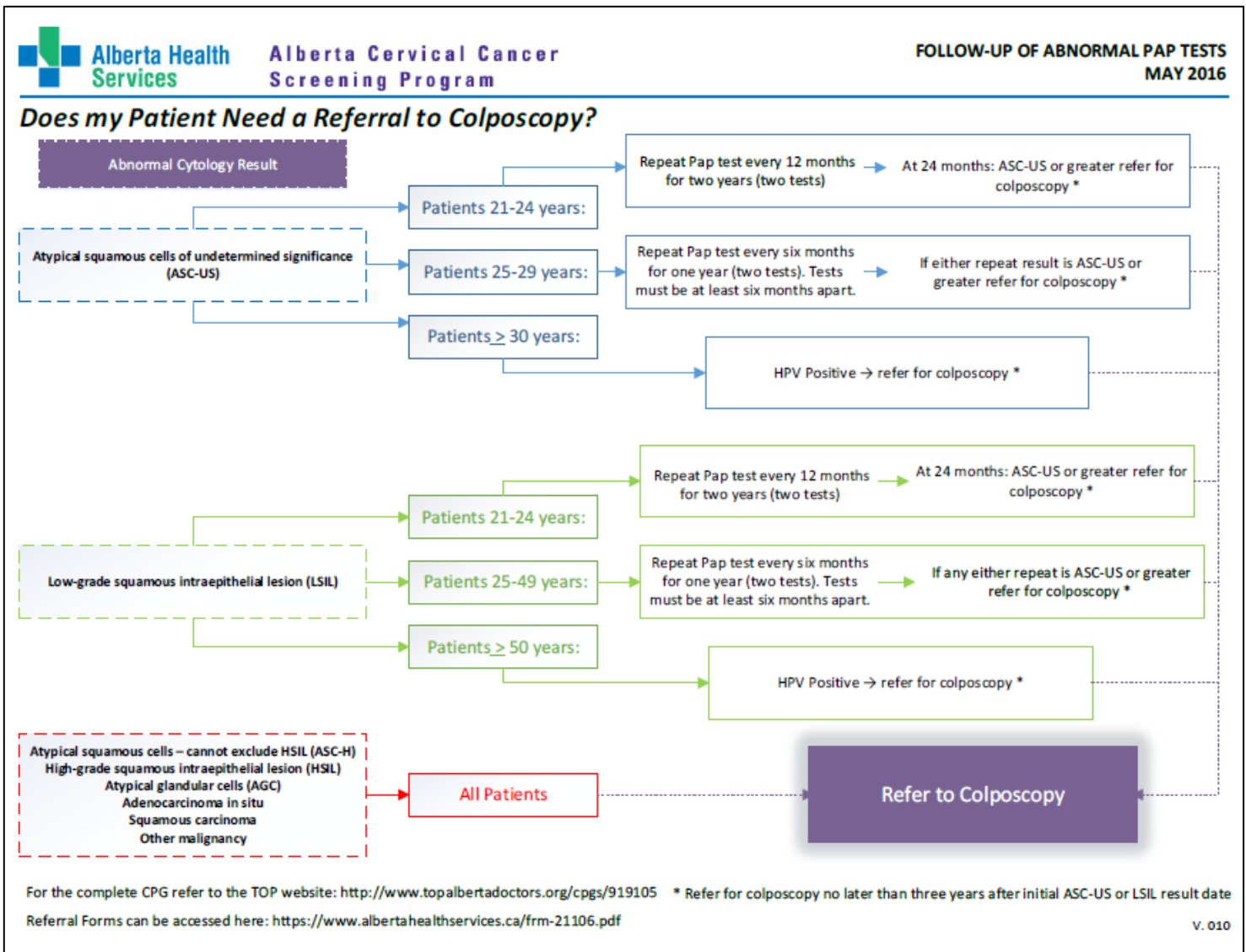

Figure 7: Does my Patient Need a Referral to Colposcopy? AHS, 2016 ([download](#))

Clients with ASC-US/LSIL and HPV Testing

Pap tests examine cells from the cervix for abnormalities that could develop into cervical cancer over time. For some low-grade lesions, the likelihood of progression is not clear. In the past, all women with low-grade lesions (ASC-US or LSIL) were recommended to repeat the Pap test at least 2 times at 6 month intervals. For a subset of these women, a reflex HPV test can determine right away whether the woman needs follow-up care.

In compliance with the 2016 TOP guideline, laboratories in Alberta perform HPV reflex testing on residual liquid-based samples for women based on their age and Pap test result. While informed consent for testing is not required, all women having a Pap test should be provided with the information sheet, “HPV Testing: Information for Women Having Pap Tests” that is included in trays of liquid based supplies and is also available at

<https://screeningforlife.ca/wp-content/uploads/2019/12/ACCSP-Info-Sheet-HPV-Testing-Information-for-Women-Having-Pap-Tests-Nov-2011.pdf>.

HPV reflex testing is performed on samples from women 30 years and older with ASC-US and women 50 years and older with LSIL cytology results (See **Figure 5** to see how to manage your clients' abnormal cytology result). For these women, high-risk HPV testing is as likely to detect high-grade precancerous lesions compared with repeat Pap testing, but with significantly fewer referrals for colposcopy. An added advantage is these abnormal results are resolved much faster and women aren't lost to follow-up.

Women with negative HPV reflex test results should return to routine screening because their risk of significant pathology in the next two years is less than 2%, which is virtually indistinguishable from women with negative cytology for whom HPV results are unavailable. When reflex HPV results are positive, women are referred to a specialist for colposcopy.

For women 21-29 years with ASC-US and women 21-49 years with LSIL, HPV reflex testing is not helpful in deciding which women need follow-up care. For these women, repeat cytology is advised at 6 months and at 12 months. If either repeat finding is ASC-US or worse, the woman is referred for colposcopy. If both follow-up tests are negative, the woman is returned to routine screening.

Colposcopy

All women with high-grade lesions on Pap tests (ASC-H or higher), those who are HPV-positive on reflex testing (see above), and those with a repeat finding of ASC-US or LSIL are recommended for colposcopy or specialist care.

Colposcopy is used to closely examine abnormalities of the cervix. The cervix is magnified through a binocular scope with high intensity light. This allows for the identification of abnormalities based upon:

- Epithelial density (white epithelium)
- Vascular patterns (punctuation, etc.)

Using these parameters, an area of abnormality can be identified in order to direct a tissue biopsy by one of several available methods (punch biopsy, loop electrosurgical excision procedure (LEEP), etc.).

Referring to Colposcopy

The referral to colposcopy form requires a Physician or Nurse Practitioner's Prac ID. Ensure you have a relationship with a Physician or Nurse Practitioner to maintain continuity of care throughout the screening pathway. See [Appendix 1: Recommended Policies](#).

The ACCSP Colposcopy Referral Form can be found here:
<https://www.albertahealthservices.ca/frm-21106.pdf>.



Women currently being assessed by a colposcopy clinic, including those who do not show up for their appointments, should not undergo additional Pap testing until discharged from colposcopy.

Special Circumstances

For women under 21 years with abnormal results:

- Routine screening in this age group is not recommended. Dysplastic lesions in this age group are most likely to resolve spontaneously.³¹ If women younger than 21 years are screened, referrals for colposcopy should be minimized while carefully monitoring for progression. See modified follow-up guidelines for women younger than 21 years with Pap test findings of ASC-US or LSIL in the *Guideline for Screening for Cervical Cancer*.¹
- In women younger than 21 years with ASC-US or LSIL, HPV DNA testing is unacceptable. This is because HPV is so frequent in this age group that HPV testing would result in a high rate of colposcopy with a very low probability of cervical carcinoma or progressive disease. If inadvertently performed, the HPV test results should not influence management.

Pregnant women with abnormal results

- Pregnant women should be screened according to the guidelines by their Physician, Nurse Practitioner, (or Registered Midwife) with care taken not to overscreen. There is no need to perform Pap tests during pre-natal and post-partum visits unless the woman is otherwise due for screening or is unlikely to return for screening at an appropriate time. In addition, cervical changes associated with pregnancy and birth make Pap tests more difficult to interpret.
- If ASC-US or LSIL is detected during pregnancy, it is not advised to repeat the Pap test until 6 months post-partum. All other findings, especially more advanced lesions, should be managed according to the guidelines.

Women who are estrogen depleted with abnormal results

- Women who are estrogen depleted may have atrophic cells on the Pap test. These atrophic cells may falsely mimic intraepithelial abnormalities and may be reported as a cytologic abnormality with atrophy.
- The lab will conduct routine HPV reflex testing for women 50 years and older with ASC-US or LSIL results. If the HPV result is negative, the woman can return to routine screening. If the result is positive, she should be referred for colposcopy.

Recommended Readings

1. *Guideline for Screening for Cervical Cancer*¹ at http://www.topalbertadoctors.org/cpgs/?sid=2&cpg_cats=15.

POST-TEST

Complete the following Post-Test after completing Sections 1-10. The answer key is provided in [Appendix 3: Answer Key Pre-Test & Post-Test](#).

Instructions for Test Completion

For multiple choice questions, please indicate **ALL** correct answers as appropriate. For open-ended questions, please provide **at least as many** responses as the question asks for.

1. RNs in Alberta are expected to practice in a manner consistent with:
 - a. *Health Professions Act (HPA) (2000; 2005; 2018)*
 - b. *CARNA Practice Standards for Regulated Members (2013)*
 - c. *CARNA Restricted Activities Standards (2019)*
 - d. *Canadian Nurses Association (CNA) Code of Ethics for Registered Nurses (2017)*
 - e. *CARNA Cervical Cancer Screening Practice Advice (2018)*

2. The responsibilities of Employers of RNs who are expected to provide Pap tests as part of their position include:
 - a. Providing adequate education time, resources, preceptorship opportunities, and facilities
 - b. Ensuring that there is an explicit relationship with the RN taking the Pap test and a Physician or Nurse Practitioner
 - c. Developing policies and procedures related to RN Pap testing
 - d. Participating in ongoing monitoring of Pap test adequacy rates
 - e. Maintaining a record of RN Pap test education

3. The cornerstones of women-centered care include which of the following factors?
 - a. A focus on women
 - b. Involvement and participation of women
 - c. Empowerment
 - d. Respect and safety

4. Which of the following is not a risk factor for cervical cancer?
 - a. Multiple male sex partners
 - b. Early onset of first intercourse
 - c. Genital infections such as herpes simplex II (HSV2) and Chlamydia
 - d. Family history
 - e. HPV infection
 - f. Smoking

5. The Alberta Cervical Cancer Screening Program is needed because:
 - a. Organized cervical cancer screening programs reduce the rates of cervical cancer
 - b. Having regular Pap tests may prevent a few cervical cancers
 - c. Supporting women to have regular Pap tests can prevent almost all cervical cancers
 - d. All clients who develop cervical cancer in Alberta have not had regular Pap tests
 - e. More than ½ of the clients who develop cervical cancer in Alberta have not had regular Pap tests

6. All women between the ages of 25 to 69 who have ever been sexually active should have Pap tests regularly. (Except women who have had a hysterectomy for benign reasons with no history of biopsy confirmed high-grade lesions or cervical cancer).
 - a. True
 - b. False

7. Name four high risk groups in particular whom RNs should encourage to have Pap tests regularly.
 - _____
 - _____
 - _____
 - _____

8. Women older than 69 who have never been screened for cervical cancer need 3 negative and satisfactory routine Pap tests (including a negative HPV reflex test) before screening can be discontinued.
 - a. True
 - b. False

9. Women younger than 21 who have been sexually active for 3 years need to be screened for cervical cancer.
 - a. True
 - b. False

10. Which age group is least likely to benefit from increased access to and promotion of Pap testing?
 - a. Women aged 50 to 69
 - b. Women aged 36-49
 - c. Women aged 25-35
 - d. Women under 21



11. List four reasons why an eligible woman may be reluctant to have a Pap test.

- _____
- _____
- _____
- _____

12. If a client appears apprehensive before the pelvic exam, it is best to:

- a. Reassure her and press forward
- b. Tell her that there is nothing to worry about
- c. Ask open-ended questions about her apprehension around the Pap test procedure

13. List four key things that should be discussed with the client after the Pap test visit.

- _____
- _____
- _____
- _____

14. List five client groups that may have special learning, counselling, and educational needs related to cervical cancer screening.

- _____
- _____
- _____
- _____
- _____

15. Which of the following findings related to STI might be discovered during an external genital examination?

- a. Pubic lice/crabs
- b. Genital warts
- c. Genital herpes
- d. Inflammation of the Bartholin's glands



16. A client presents with the following symptoms:

- Raised painless lesions on the labia, the vestibule, and/or in the perianal region
- Flesh-colored cluster of soft growths

The client most likely has:

- a. Molluscum contagiosum
- b. Nabothian follicles
- c. Genital herpes
- d. Genital warts
- e. Yeast infection

17. List six abnormal findings of the ectocervix:

- _____
- _____
- _____
- _____
- _____
- _____

18. Which of the following are abnormal findings on the cervix that should be referred to a Physician or Nurse Practitioner?

- a. Friable tissue (soft, eroded)
- b. Red patchy areas
- c. Abnormal bleeding and inflammation
- d. Granular areas, white patches
- e. Pink colour

19. Name the three sampling areas of the cervix:

- _____
- _____
- _____



20. A client reports that they completed their complete set of HPV immunization vaccines and questions if they should have a Pap test. What is the correct response?
- The client does not need to have a Pap test for five years after immunization
 - The client is immunized and no longer requires Pap tests in their lifetime
 - The client only requires a Pap test if they are symptomatic
 - It is very important the client still gets regular Pap test screening even if they have been vaccinated
21. Women due for a Pap test who are pregnant or who have had a total or subtotal hysterectomy due to biopsy confirmed high-grade lesions or cervical cancer should be referred to a Physician, Nurse Practitioner, (or Registered Midwife) for a Pap test.
- True
 - False
22. A smaller and narrower speculum should be used with:
- Clients who have not engaged in full vaginal penetration during sexual activity
 - Nulliparous clients
 - Circumcised clients
 - Clients whose vaginal orifices have contracted post-menopausally
23. It is acceptable to lubricate the speculum with:
- A very small amount of water soluble lubricant
 - Warm water
 - Vaseline
24. An acceptable way to insert the speculum is:
- Blade tips against the upper (anterior) wall of the vagina
 - At an oblique angle
 - With the speculum closed
 - With the speculum slightly opened
 - With the speculum angled 45° downward toward the small of the client's back

25. The best way to reposition a speculum for a client with a cervix with posterior orientation is:
- Reinsert less deeply and anteriorly, with the base of the lower blade actually compressing the anterior wall of the vagina.
 - Insert the speculum more deeply and posteriorly through compression of the perineal tissue. The blade tips will slip under the cervix into the posterior fornix.
 - Choose a plastic speculum of a larger size and reinsert as you did prior.
26. What are the ideal client conditions for cervical screening?
- Avoidance of vaginal douching for 24 hours before the test.
 - Avoidance of use of contraceptive creams or jellies for 24 hours before the test.
 - Avoidance of intercourse for 24 hours before the test.
 - Mid-cycle.
 - During menses.
27. The correct way to obtain an ectocervix specimen with spatula is:
- Rotate spatula in cervical os only 360° and end rotation so spatula is in 3 and 9 o'clock position.
 - Rotate spatula in cervical os only 180° and end rotation so spatula is in 3 and 9 o'clock position.
 - Rotate spatula in cervical os only 90° and end rotation so spatula is in 3 and 9 o'clock position.
28. The correct way to obtain a specimen with a cytobrush is:
- Insert the cytobrush gently all the way into the cervical os but no further than the end of the bristles and turn 90° to 180°.
 - Insert the cytobrush gently all the way into the cervical os but no further than the end of the bristles and turn 180° and back again.
 - Insert the cytobrush gently all the way into the cervical os but no further than the end of the bristles and turn 360°.
29. Over rotation of the endocervical brush will cause cell damage and slight capillary bleeding.
- True
 - False
30. Unsatisfactory Pap tests are mostly a result of the following:
- Cervical sampling issues
 - Specimen collection issues

31. List six key descriptions that could be documented following a Pap test visit:

- _____
- _____
- _____
- _____
- _____
- _____

32. During a Pap test visit, when does the RN seek to obtain informed verbal consent from the client?

- a. At the start of the consultation.
- b. After you have explained the external exam, speculum exam, and the Pap test procedure and before you begin.
- c. After completing the external exam, speculum exam, and the Pap test.

33. Is the RN legally responsible to protect confidentiality of client health information?

- a. Yes
- b. No

34. An informal verbal agreement between an RN and a Physician or Nurse Practitioner should be used to outline the RN's role in performing Pap tests.

- a. True
- b. False



Case Study #2

A 52 year old female client presents at a large urban health centre. During the health history, she states that she has some itchiness and watery vaginal discharge. On performing a speculum examination you note that the vagina is red and granular looking. There is a frothy yellowish foul-smelling vaginal discharge.

1. What may be causing the above symptoms?
2. Outline the plan of care you will discuss with this client.
3. Outline your educational and counselling strategies with this client.

Case Study #3

25 year old aboriginal client presents at a Well Baby clinic on a reserve community. She has her husband and a 4 month old baby with her and has a 2 and 3 year old at home. She is trying to get pregnant again. Discussion ensues as to her plan for a pregnancy so soon after this birth. She is slow to answer. The husband finally says that his wife has been told that she had an "abnormal cancer test" during her last pregnancy and that she was referred to the Women's Centre at her 6 week postpartum doctor's visit. She did not attend the postpartum doctor's visit because she is afraid that she has cancer "down there". The client wants to have more babies before she has surgery. The client and her husband both think she will have her "womb taken out".

1. What is the first priority for this client?
2. Should the RN do cervical screening?

Case Study #4¹

A 38 year old female client presents in Well Women's Clinic. On taking her health history you note that she has not menstruated for a couple of months but she indicates that her periods are often irregular and she doesn't think that she is pregnant. She has never had a Pap test and agrees to have one done today. On performing a speculum examination you note a bluish discolouration of the cervix. There is also a thin, creamy, gray-white, vaginal discharge. There is no inflammation on the vaginal wall or cervix.

1. What may be causing the discolouration of the cervix?
2. What may be causing the vaginal discharge?
3. How would you proceed?
4. Outline your educational and counselling strategies with this client.

Case study #5

A 62 year old aboriginal client presents for her Pap test. She has not been in for regular screening in the past. The client is very self-conscious about her body as she believes that she is overweight. She has developed a good trusting relationship with her RN who has recently been certified to do cervical screening. The history is taken and there are no signs to indicate that this will be anything other than a routine screening. Upon examination the client becomes tense and somewhat upset. The RN has trouble finding the clients cervix. The client continues to become more anxious and starts to cry, saying that the examination is painful.

1. What is the first priority for this client?
2. With a nervous client, what are some ideas to promote comfort?
3. When the client starts to cry, what should you do?
4. The cervix is pink and fleshy, but has some "bumps on it. What might this be and what should you do?

Case study #6

You work in a low socioeconomic inner city practice with multiple immigrant women, many of whom do not have English as a first language. A 65 year old client of East Indian background attends your office for the first time to get her blood pressure checked. She is a smoker. She has moved to stay with her son and help look after her grandchildren. She is mildly obese. She says that she has had no Pap since having children (the last child was born 45 years ago), that she has only rare sexual activity with her husband of many years and why would she need a Pap.

She still has periods each month but they are getting heavier and closer together, i.e. q 3 weeks. When asked about previous Pap tests she said, I had a few when I was younger, in my 20's and they said one was abnormal, so I had to have more frequent examinations at the Physician's office". She says that she really doesn't want any more Pap tests.

1. What if this client had had a hysterectomy, how would you deal with the idea of doing a Pap test?
2. What else would you like to know about this client, particularly in regard to her risk for cervical cancer?
3. How would you discuss the risk of cervical cancer with her?
4. What if she agrees to have a basic assessment (e.g. blood pressure) but still refuses a Pap test - what would you do?

GLOSSARY

A

Adenocarcinoma: A cancer that is derived from glandular tissue or in which the tumour cells form recognizable glandular structures. Most pancreatic cancer and prostate cancer, for example, are adenocarcinomas. About 15% of cervical cancers in Alberta are adenocarcinoma.

Adequacy rate: Is the number of unsatisfactory Pap test results divided by the total number of Pap test results received in a specific period. Specimen adequacy rates differ between the labs based on the type of liquid based cytology that is used and the process for analyzing specimens within the lab.

Adhesion: Scar tissue that unites surfaces which are normally separate. Adhesions can occur in the abdominal cavity, fallopian tubes, or inside the uterus. Adhesions can interfere with transport of the egg and implantation of the embryo in the uterus.

AGC: Atypical Glandular Cells.

Alberta Cervical Cancer Screening Program (ACCSP): The ACCSP is a provincial population-based screening program that develops and coordinates activities that contribute to the prevention and early detection of cervical cancer.

Alberta Health Services (AHS): AHS is Canada's first and largest province wide, fully-integrated health system, responsible for promoting the wellness of and delivering health services to the residents of Alberta.

Alberta Health Services (AHS) Zone: AHS is organized into five geographic zones so that communities are more directly connected to their local health systems and decisions can be made closer to where care is provided. The five zones are: North Zone, Edmonton Zone, Central Zone, Calgary Zone and South Zone.

Amenorrhea: Absence of menstrual flow.

Anovulation: Absence of ovulation.

Anteflexed uterus: Normal position in which the body of the uterus tips forward toward the bladder.

Anteverted uterus: Normal position in which the body of the uterus tips forward toward the bladder, but at a less acute angle than if anteflexed.

ASC-H: Atypical Squamous Cells – cannot exclude High-Grade Squamous Intraepithelial Lesion (HSIL).

ASC-US: Atypical Squamous Cells of Undetermined Significance.

Asymptomatic: A person who does not report symptoms and appears without signs of disease.

B

Bartholin's glands: Two small mucous glands located on each side of the vaginal orifice; their ducts open on the vulva.

Benign: Cell changes that have nothing to do with cancer.

Biopsy: The removal and examination of a small amount of tissue to establish a diagnosis.

Breakthrough bleeding: Vaginal spotting or bleeding that occurs between periods and is caused by the failure of progestin (usually taken in combination with estrogen as an oral contraceptive) to support the endometrium adequately.

C

Cancer: A general term for more than 100 diseases. It is the uncontrolled, abnormal growth of cells that can invade and destroy healthy tissue. Most cancers can also spread to other parts of the body.

Carcinoma: One of the five basic kinds of cancer and the most common. It begins in epithelial tissue (the lining or covering of an organ; makes up the majority of malignancies of the breast, uterus, intestinal tract, skin and tongue).

Carcinoma in situ: An early stage of cancer in which tumour cells are confined to the epithelial tissue or origin and have not yet invaded surrounding tissues.

Caruncles (of the urethra): Fleshy outgrowths of the mucous membrane of the female urethral mucosa.

Cervical Cancer Screening: Comprehensive screening process that tests eligible women for abnormal or precancerous cervical cells inclusive of providing the necessary follow-up.

Cervical carcinoma: A cancer of the uterine cervix (the neck of the uterus).

Cervical dysplasia: An abnormal tissue growth on the cervix that may progress to cancer if not treated in time; detected through a Pap test.

Cervical ectropion: Eversion of the epithelium onto the cervix.

Cervical eversion: When the tissue within the cervix "opens up" onto the outer part of the cervix.

Cervical stenosis: A partial or complete blockage of the cervical canal which can be a congenital defect or caused by surgical complications, infections, and/or radiation therapy.

Cervicitis: An inflammation of the cervix caused by one of a number of different organisms and generally classified as either acute or chronic.

Cervix: The neck or lower end of the uterus or womb that connects the uterus with the vagina.

Chemotherapy: The use of drugs to treat or control cancer.

Clinical Practice Guideline (CPG): Refers to TOP Cervical Cancer Screening Clinical Practice Guideline, see <https://top.albertadoctors.org/CPGs/Lists/CPGDocumentList/Cervical-Cancer-Screening-Summary.pdf>.

Circumoral erythema: Redness of the skin caused by dilatation and congestion of the capillaries, can be a sign of inflammation or infection.

Colposcopy: Examination of the cervix and vagina using a low-powered magnifying instrument known as a colposcope in order to assess the extent and severity of any problem and to determine appropriate treatment. Small biopsies may be taken during the test.

Competence: The integration and application of knowledge, attitudes, skills and judgement required for performance in a designated role and setting.

Cone biopsy: Also known as **conization**, refers to a surgical removal of a cone-shaped specimen of tissue from the distal end of the cervix for examination under a microscope; provides a more extensive sample for diagnosis than a simple biopsy.

Conization: See Cone Biopsy.

Cryosurgery: A surgical procedure that uses extreme cold to destroy abnormal tissue by freezing. A general anesthetic is not required.

Cystocele: Herniation of the bladder through the anterior vaginal wall (bulging of the bladder into the vagina).

D

Diethylstilbestrol (DES): A synthetic form of estrogen once used to treat menstrual disorders and to prevent miscarriage but is no longer prescribed for these cases because of the occurrence of reproductive abnormalities and cancers in the offspring of women so treated.

Diagnosis: Identification of a disease from signs, symptoms, patient history, laboratory tests, radiological results and physical findings.

Dysmenorrhea: Menstrual discomfort or pain.

Dyspareunia: Pain or discomfort in the vagina or pelvis during sexual intercourse.

Dysplasia: Abnormal tissue growth on the cervix that may progress to cancer if not treated in time; abnormal cell changes that are detected through a Pap test.

E

Eligible women: Asymptomatic women within the target population who are at risk for developing cervical cancer.

Endocervical curettage (ECC): The removal of tissue from the inside of the cervix using an instrument called a curette.

Erythema: Redness.

Excoriation: Damage to skin e.g. by scratching.

Exudate: Fluid or discharge usually as a result of inflammation.

F

False-negative: When a Pap test incorrectly gives a negative result when the disease or condition in question is actually present in the individual being screened.

False-positive: When a Pap test incorrectly gives a positive result when the disease or condition in question is not actually present in the individual being screened.

Fimbriae: Any structure resembling a fringe or border.

Fissure: A narrow slit or cleft.

Fistula (of the urethra): Abnormal passage between the urethra and another structure such as the vagina or rectum.

Fornix/Fornices: The anterior (front) and posterior (back) recesses into which the upper vagina is divided. These vault like recesses are formed by protrusion of the cervix into the vagina.

Fourchette: The place where the labia minora meet posteriorly.

Friability: Referring to tissue which is fragile and may bleed easily (e.g. when a swab is taken).

FSH: Follicle-stimulating hormone.

G

Glandular premalignancy and malignancy: A pathology result of atypical glandular cells, endocervical adenocarcinoma in situ, or adenocarcinoma.

Gonadotropin-releasing hormone (GnRH): Responsible for the release of follicle stimulating hormone and luteinizing hormone from the anterior pituitary.

Gravida: Number of pregnancies, regardless of their outcomes.

H

High-grade abnormality: A Pap test result of ASC-H or worse.

Homogenous: Same quality, composition and/or structure throughout.

Human Papillomavirus (HPV): HPV is the common name for a group of related viruses, some of which occur on the cervix and cause cervical cancer.

HPV Vaccine: A vaccine used to prevent infection caused by certain types of HPV.

HSIL: High-Grade Squamous Intraepithelial Lesion.

HSV 1 or 2: Herpes simplex virus one and two. HSV 1 causes oral herpes and HSV 2 causes genital herpes. HSV-1 can also cause genital herpes through transmission during oral-genital sex.

Hymenal remnants: The tissue of the hymen that is still present.

Hyperemia: Congestion or increased blood flow to the area.

Hysterectomy: Surgical removal of the uterus. The ovaries may also be removed at the same time.

I

Immunocompromised: When a woman has a medical condition or is taking medications which result in reduced functioning or effectiveness of the body's natural immune functions. Examples include HIV infection, cancer treatments or on high doses of corticosteroids.

Inactivity criteria for hysterectomy: Visual inspection that the cervix has been removed and no previous history of biopsy-confirmed high-grade cervical lesions or cervical cancer.

Incidence: The number of new cases of a disease occurring during a specific time period in a defined population.

Increased surveillance: When a woman should be screened more frequently than the general population because she is at higher risk of developing cervical epithelial cell abnormalities.

Induration: Abnormally hard spot.

Ineligibility form: A form submitted by primary healthcare practitioners confirming that their client meets the ineligibility criteria.

Infertility: The inability to conceive over a period of 1 year of unprotected regular intercourse. Contributing factors in women include abnormalities of the vagina, cervix, uterus, fallopian tubes, and ovaries. Factors influencing fertility in both women and men include stress, nutrition, chemical substance use, chromosomal abnormalities, certain disease processes, sexual and relationship problems, and immunologic response.

Introitus: Opening to the vagina located on the perineum.

Invasive cervical cancer: A stage of cervical cancer in which the cancer has spread from the surface of the cervix to healthy tissue deeper in the cervix or to other parts of the body.

L

Laparoscopy: Examination of internal organs through use of a small telescope called a laparoscope.

Laser surgery: Use of an intense, narrow beam of light (called a laser beam) to treat some forms of cancer or abnormal cells. Since a laser beam can be focused precisely on a tiny area, it is used to operate on delicate tissues. General anesthetic is unnecessary.

LEEP: Loop electrosurgical excision procedure. After freezing the cervical area, an electrical wire loop is inserted into the vagina and all the abnormal tissue that can be seen on the cervix is sliced off and removed.

Leukoplakia (of the cervix): Raised white plaques on the cervix, may be due to different causes such as carcinoma or genital warts.

LH: Luteinizing hormone.

Lithotomy position: Client lies on back, legs flexed at the knees, thighs flexed and abducted. Stirrups may be used to support the feet.

Liquid based cytology: A technology that uses a plastic spatula and brush, or broom (depending on product used) to take a Pap test for cervical cancer screening. The sample is then either swirled or dropped into a liquid preservative in a specimen container. The sample is then spun in the lab to remove extraneous materials and a slide prepared for examination under a microscope.

Localized cancer: A cancerous growth that has not spread to other parts of the body.

Low-grade abnormality: A Pap test result of ASC-US or LSIL.

LSIL: Low-Grade Squamous Intraepithelial Lesion.

M

Malignancy: A tumour consisting of cancerous cells. Cells from a malignant growth can break away and start secondary tumours elsewhere in the body.

Malignant: Cancerous; tending to metastasize or spread.

Menarche: Onset of menstrual periods, usually occurring between age 9 and 17.

Menopause: Cessation of menstrual periods that occurs with the decline of cyclic hormonal production and function that accompanies aging. Premature menopause may occur as a result of, for example, illness or the surgical removal of both ovaries.

Metastasis: The spread of cancer cells from the original tumour to other parts of the body by way of the lymph system or bloodstream.

Mortality rate: The number of deaths in a population in a given period or area or from a certain cause.

Multigravida: A woman who has been pregnant several times.

Multiparity: Condition of having two or more pregnancies that resulted in viable fetuses.

N

NILM (Normal): Negative for Intraepithelial Lesion or Malignancy.

Nulliparty: Condition of never having delivered a viable infant.

O

Oncologist: A Physician who specializes in diagnosing and treating cancer.

Oncology: The study and treatment of cancerous tumours.

Oophorectomy: Surgical removal of the ovaries.

Orthopnea: Ability to breathe easily only in the upright position.

P

Papanicolaou (Pap) test: A test in which cells are removed from the cervix and examined under a microscope. Devised by Dr. George Papanicolaou, the Pap test is an effective way to detect abnormal cells (see cervical dysplasia) or cancer. Since the Pap test (like many medical tests) is not perfect, it is important to Pap test women on a regular basis to lessen the chance of missing any abnormal cell changes.

Parity: Condition of having delivered an infant or infants, alive or dead, during the viability period (fetus weighing 500 g or more or having a minimum estimated 20-week gestation); multiple birth is a single parity.

Partial hysterectomy: A hysterectomy in which the cervix is left in place.

Pelvic exam: Also called an internal examination; a gynecological examination of a woman's vagina, vulva, cervix, fallopian tubes, ovaries, and uterus.

Pelvic Inflammatory Disease (PID): PID is an inflammatory condition of the pelvic cavity that may involve the uterus, fallopian tubes, ovaries, pelvic peritoneum or pelvic vascular system; often caused by gonococcal and chlamydial infection, may be acute or chronic. Acute PID causes bilateral tenderness in the adnexal areas and the client may guard the area. The symptoms of chronic PID are bilateral, tender, irregular, and fairly fixed adnexal areas; movement of cervix is painful.

Perineum: The area between the anus and the vulva.

Polyp: a growth of tissue or mass protruding from a mucous membrane; can occur wherever there is a mucous membrane including colon, bladder, uterus, cervix, vocal cords, or nasal passage; usually benign, they can lead to complications or eventually become malignant.

Preceptor: a RN, Nurse Practitioner, or Physician experienced and competent in well-woman care and performing Pap tests, who will oversee the educational process and be willing to participate in the required learning activities.

Premenstrual syndrome (PMS): A cyclic cluster of signs and symptoms, such as breast tenderness, fluid retention, and mood swings, that occur cyclically usually after ovulation and before or during menses; characterized by at least 7 symptom-free days, usually in the first half of the menstrual cycle.

Puberty: Period when secondary sexual characteristics begin to appear and potential for sexual reproductive ability is obtained.

R

Rectocele: Herniation of part of the rectum through the vaginal wall.

Retroflexed uterus: Normal position in which the uterine corpus flexes posteriorly toward the rectum at an acute angle.

Retroverted uterus: Normal position in which the uterine corpus flexes toward the rectum, but at a less acute angle than if retroflexed.

Risk factor (in relation to cancer): Anything that increases a person's chances of developing cancer. For example, smoking is a risk factor for lung, head/neck and cervical cancer.

Rugose: Marked by ridges, wrinkled.

S

Salpingitis: Inflammation or infection of the fallopian tube that is often associated with pelvic inflammatory disease (PID); causes lower quadrant pain with tenderness on bimanual examination.

Screening programs: A department of Alberta Health Services that provides leadership in the coordination and delivery of three organized cancer screening programs in Alberta: the Alberta Breast Cancer Screening Program (ABCSP), the Alberta Cervical Cancer Screening Program (ACCSP) and the Alberta Colorectal Cancer Screening Program (ACRCSP).

Sexually active: Refers to both sexual intercourse and intimate genital contact including vaginal, anal, oral, and digital sexual activity.

Sexually Transmitted Infection (STI): Sexually transmitted infection, which includes Sexually Transmitted Diseases and other infections that may not manifest as disease.

Skene's gland: Glands lying just inside of and on the posterior area of the urethra in the female, one on each side of the floor of the urethra.

Speculum: A metal or plastic instrument used to spread the vagina open so that the cervix can be seen.

Squamous premalignancy and malignancy: A pathology report of ASC-US, ASC-H, LSIL, HSIL, or squamous cell carcinoma.

Stage 1B tumors: The cancerous area is larger than in stage 1A, but is still only in the tissues of the cervix and has not spread.

Stellate cervical laceration: The trauma of a difficult delivery(ies) may tear the cervix, producing permanent lacerations. In a stellate laceration, the cervix has a number of slits in a star-like pattern.

Subtotal hysterectomy: Removal of the uterus only, leaving the cervix in situ.

Symptomatic: Showing indications of disease or illness.

T

Target population: A group of persons for whom an intervention is planned. In population-based cancer screening, this includes those of a certain age, sex and living in a geographically defined area.

Total hysterectomy: Removal of the uterus and cervix.

Transverse cervical laceration: The trauma of difficult deliveries may tear the cervix, producing permanent lacerations. In a transverse laceration, the cervix appears slit from side to side.

Tubal ligation: Surgical sterilization of a woman by constricting, severing, or crushing the fallopian tubes.

Tumour: A mass of abnormally growing cells that serve no useful bodily function. Tumours can be either benign or malignant.

U

Unsatisfactory result (Unsat): Indicates that the specimen does not have enough epithelial cells available for examination or there are other substances masking the cells, such as menstrual fluid.

V

Vaginal atrophy: Often a symptom of menopause; the drying and thinning of the tissues of the vagina and urethra. This can lead to dyspareunia (pain during sexual intercourse) as well as vaginitis, cystitis, and urinary tract infections.

Vaginal vault: Describes the vagina after a hysterectomy when no cervix remains.

Vaginal vault smear: Used to detect persisting neoplasia of the lower genital tract after hysterectomy.

Vaginitis: Inflammation of the vaginal mucosa marked by pain and/or purulent discharge.

Vesicle: Small elevation of the skin containing serous fluid (e.g. blister).

Virus: An infectious organism that invades and grows in cells and thereby alters their function; cause a variety of infectious diseases and may also induce some types of cancer.

REFERENCES

1. Toward Optimized Practice (TOP) Cervical Cancer Screening Working Group. Cervical Cancer Screening: clinical practice guideline.
2. Walboomers JMM, Jacobs MV, Manos MM, et al. Human papillomavirus is a necessary cause of invasive cervical cancer worldwide. *The Journal of Pathology* 1999; 189: 12-19.
3. Schlecht NF, Kulaga S, Robitaille J, et al. Persistent Human Papillomavirus Infection as a Predictor of Cervical Intraepithelial Neoplasia. *JAMA* 2001; 286: 3106-3114.
4. Ho GY, Bierman R, Beardsley L, et al. Natural history of cervicovaginal papillomavirus infection in young women. *N Engl J Med* 1998. DOI: 10.1056/NEJM199802123380703 [doi].
5. Hildesheim A, Schiffman MH, Gravitt PE, et al. Persistence of type-specific human papillomavirus infection among cytologically normal women. *J Infect Dis* 1994. DOI: 10.1093/infdis/169.2.235 [doi].
6. Östör AG. Natural History of Cervical Intraepithelial Neoplasia: A Critical Review. *International Journal of Gynecological Pathology* 1993.
7. Bosch X and Harper D. Prevention strategies of cervical cancer in the HPV vaccine era. *Gynecol Oncol* 2006. DOI: S0090-8258(06)00570-1 [pii].
8. Trottier H and Franco EL. The epidemiology of genital human papillomavirus infection. *Vaccine* 2006; 24: S4-S15.
9. Schiffman M, Castle PE, Jeronimo J, et al. Human papillomavirus and cervical cancer. *The Lancet* 2007; 370: 890-907.
10. Canadian Cancer Society's Steering Committee on Cancer Statistics. *Canadian Cancer Statistics* 2011.
11. Goldie SJ, Kohli M, Grima D, et al. Projected clinical benefits and cost-effectiveness of a human papillomavirus 16/18 vaccine. *J Natl Cancer Inst* 2004. DOI: 10.1093/jnci/djh104 [doi].
12. Screening Programs, Alberta Health Services. *Organized Cancer Screening in Alberta* 2015.
13. Canadian Cancer Society's Advisory Committee on Cancer Statistics. *Canadian Cancer Statistics* 2015.
14. Health Canada. *Cervical Cancer Screening in Canada: 1998 Surveillance Report*.

15. Bosch FX and de Sanjosé S. The epidemiology of human papillomavirus infection and cervical cancer. *Dis Markers* 2007. DOI: 10.1155/2007/914823.
16. Winer RL, Hughes JP, Feng Q, et al. Condom Use and the Risk of Genital Human Papillomavirus Infection in Young Women. *New England Journal of Medicine* 2006; 354: 2645-2654.
17. Palefsky JM, Minkoff H, Kalish LA, et al. Cervicovaginal Human Papillomavirus Infection in Human Immunodeficiency Virus-1 (HIV)-Positive and High-Risk HIV-Negative Women. *JNCI: Journal of the National Cancer Institute* 1999; 91: 226-236.
18. Ellerbrock TV, Chiasson MA, Bush TJ, et al. Incidence of cervical squamous intraepithelial lesions in HIV-infected women. *JAMA* 2000. DOI: joc90181 [pii].
19. Frisch M, Biggar RJ and Goedert JJ. Human papillomavirus-associated cancers in patients with human immunodeficiency virus infection and acquired immunodeficiency syndrome. *J Natl Cancer Inst* 2000. DOI: 10.1093/jnci/92.18.1500 [doi].
20. Tam L, Chan AYK, Chan PKS, et al. Increased prevalence of squamous intraepithelial lesions in systemic lupus erythematosus: Association with human papillomavirus infection. *Arthritis & Rheumatism* 2004; 50: 3619-3625.
21. Kane S, Khatibi B and Reddy D. Higher incidence of abnormal Pap smears in women with inflammatory bowel disease. *Am J Gastroenterol* 2008. DOI: AJG1582 [pii].
22. Malouf MA, Hopkins PM, Singleton L, et al. Sexual health issues after lung transplantation: importance of cervical screening. *J Heart Lung Transplant* 2004. DOI: 10.1016/j.healun.2003.07.018 [doi].
23. Public Health Agency of Canada. Updated Recommendations on Human Papillomavirus (HPV) Vaccines: 9-valent HPV vaccine and clarification of minimum intervals between doses in the HPV immunization schedule.
24. National Advisory Committee on Immunization. Updated Recommendations on Human Papillomavirus (HPV) Vaccines: 9-valent HPV vaccine 2-dose immunization schedule and the use of HPV vaccines in immunocompromised populations, May.
25. Clinical Principal Committee, Standard Committee on Screening. Population Based Screening Framework.
26. IWK Grace Health Centre. Self directed learning package – women’s health program. Speculum exam, Pap smear, STD swabs. A shared competency.



27. Statistics Canada. Pap Smear, <https://www150.statcan.gc.ca/t1/tb11/en/tv.action?pid=1310049101> (2017).
28. Screening Programs, Alberta Health Services. Alberta Cervical Cancer Screening Participation Rate (42 month) By Age Group & Health Zone 2019.
29. Alberta Cancer Registry. 2009 Annual Report of Cancer Statistics.
30. Richardson H, Kelsall G, Tellier P, et al. The Natural History of Type-specific Human Papillomavirus Infections in Female University Students. *Cancer Epidemiology Biomarkers & Prevention* 2003.
31. Moscicki A, Shiboski S, Hills NK, et al. Regression of low-grade squamous intra-epithelial lesions in young women. *The Lancet* 2004; 364: 1678-1683.
32. Sasieni P, Adams J and Cuzick J. Benefit of cervical screening at different ages: evidence from the UK audit of screening histories. *British Journal of Cancer* 2003; 89: 88-93.
33. Nanda K, McCrory DC, Myers ER, et al. Accuracy of the Papanicolaou Test in Screening for and Follow-up of Cervical Cytologic Abnormalities: A Systematic Review. *Annals of Internal Medicine* 2000; 132: 810-819.
34. Ronco G, Cuzick J, Pierotti P, et al. Accuracy of liquid based versus conventional cytology: overall results of new technologies for cervical cancer screening: randomised controlled trial. *BMJ* 2007; 335: 28.
35. Melnikow J, McGahan C, Sawaya GF, et al. Cervical intraepithelial neoplasia outcomes after treatment: long-term follow-up from the British Columbia Cohort Study. *J Natl Cancer Inst* 2009. DOI: 10.1093/jnci/djp089 [doi].
36. Strander B, Andersson-Ellström A, Milsom I, et al. Long term risk of invasive cancer after treatment for cervical intraepithelial neoplasia grade 3: population based cohort study. *BMJ* 2007. DOI: 10.1136/bmj.39363.471806.BE.
37. Soutter WP, Sasieni P and Panoskaltsis T. Long-term risk of invasive cervical cancer after treatment of squamous cervical intraepithelial neoplasia. *Int J Cancer* 2006. DOI: 10.1002/ijc.21604 [doi].
38. Sawaya GF, McConnell KJ, Kulasingam SL, et al. Risk of Cervical Cancer Associated With Extending the Interval Between Cervical-Cancer Screenings. *Obstetrical & Gynecological Survey* 2004; 59: 93-95.

39. Young TK and Katz A. Survivors of sexual abuse: clinical, lifestyle and reproductive consequences. *CMAJ : Canadian Medical Association journal = journal de l'Association medicale canadienne* 1998; 159: 329-334.
40. Seidel HM, Ball JW, Dains JE, et al. *Mosby's guide to physical examination*. 7th ed. ed. St. Louis: Mosby/Elsevier, 2011.
41. Canadian Cancer Society. Symptoms of uterine cancer (2019).
42. Canadian Cancer Society. Symptoms of ovarian cancer (2019).
43. World Health Organization. Female genital mutilation, <https://www.who.int/news-room/fact-sheets/detail/female-genital-mutilation> (2018).
44. Faculty of Primary Care Nurse Practitioner Program and Saskatchewan Institute of Applied Science and Technology. Pap Testing and Bimanual Exam (for Seminar 260).
45. Saslow D, Runowicz CD, Solomon D, et al. American Cancer Society Guideline for the Early Detection of Cervical Neoplasia and Cancer. *CA: A Cancer Journal for Clinicians* 2002; 52: 342-362.
46. Kotaska AJ and Maticic JP. Cervical cleaning improves Pap smear quality. *CMAJ* 2003.
47. Anonymous *The Bethesda system for reporting cervical cytology : definitions, criteria, and explanatory notes*. 2nd ed. ed. New York: Springer, 2004.
48. Solomon D, Davey D, Kurman R, et al. The 2001 Bethesda System: Terminology for Reporting Results of Cervical Cytology. *JAMA* 2002. DOI: 10.1001/jama.287.16.2114.

APPENDIX 1: RECOMMENDED POLICIES

The following is a summary, as noted throughout the module, of recommended areas for Employers to develop written policies and procedures. Some Employers may wish to develop more extensive policies.

Supporting practice advice and guidelines can be accessed here:

CARNA Role of RN's in Cervical Cancer Screening: https://www.nurses.ab.ca/docs/default-source/document-library/practice-advice/registered-nurse-role-in-cervical-cancer-screening.pdf?sfvrsn=dc75f8fd_8

ACCSP Cervical Cancer Screening Provided by Registered Nurses Guidelines: <https://screeningforlife.ca/wp-content/uploads/ACCSP-RN-Guideline.pdf>

In addition to other relevant client care/services policy, specific policies relevant to RNs performing cervical cancer screening are recommended in the following areas with regular reviews and update:

Documentation

Policy is needed for clinical areas that require particular documentation.

Evaluation for Learning Module and Practicum Improvements

Policy to require that RNs complete the evaluation of the Cervical Cancer Screening Learning Module for Registered Nurses and practicum. Policy for the development of a feedback loop to help improve this learning module and the Employer to improve the practicum experience.

Infection Control

Policy to ensure clean decontaminated instruments is used to prevent transmission of infection or cross infection (e.g., HPV) to the client.

Pap Test Adequacy

It is recommended that RNs learning to perform Pap tests have regular feedback from their Employer regarding adequacy rates and that steps are taken to help the RN increase adequacy rates as required. It is recommended that Employers set up a process to regularly collect and review Pap test adequacy rates with the RN.

Depending on the lab, RNs performing Pap tests may receive biannual reports from labs should their adequacy rate fall below the threshold established by the lab for that reporting period. It is recommended that RNs share these reports with their Employer/practice setting. Employers and practice settings must ensure steps are taken to help the RN increase adequacy rates as required.

Pap Testing Competency

ACCSP Guideline *Cervical Cancer Screening Provided by Registered Nurses* recommends that RNs perform at least 12 satisfactory Pap tests annually to maintain competence. A policy on how often the RN must demonstrate competence in taking Pap tests should be established. This will vary

depending on the number of Pap tests taken by the RN on a yearly basis and other factors including adequacy rates. It is the RN's responsibility to review ongoing competence and the Employer's responsibility to establish standards within the clinical area. It is recommended that a formal process be developed for such review.

Preceptor Relationship

Policy on preceptorship and Preceptor feedback process.

Referrals to Primary Care Provider

Policy that identifies the need for a RN to have an explicit written agreement and/or Employer relationship with a Physician or Nurse Practitioner for the purposes of:

- Consultation during a Pap test if abnormal results are suspected
- Management and follow-up of Pap results OR Employer/practice setting must secure an appropriate referral mechanism for abnormal results requiring referral and follow-up by Physician or Nurse Practitioner (may include referral to colposcopy).

Policy for appropriate referral processes for clients with the following concerns:

- High risk and/or symptoms of STI
- Abnormal findings on external or internal examination
- Cervical abnormalities
- Total or subtotal hysterectomy due to biopsy confirmed high-grade lesions or cervical cancer
- Pregnancy

RN Practice & the Health Profession Act

Policy on RN practice, continuing competency, and familiarity with the Health Professions Act (HPA).

RN Pap Test Learning Module Updates

Policy to require regular review of the RN Pap Test Learning Module. Updated versions can be obtained from https://screeningforlife.ca/for-health-providers/cervical-screening-information/#rn_pap_module_resources

Sexual Abuse

How to manage follow-up and referral of clients with a history of sexual abuse.

APPENDIX 2: ASSESSMENT TOOLS

Pap Test Skills Checklist ([download](#))

The Preceptor is encouraged to offer regular feedback to the RN. It is recommended that a Preceptor feedback process be set up in the employing clinic/agency. Once the RN has indicated readiness for final assessment, the attached tool can be used to assess the RN’s performance during several Pap related client visits. The RN should attain 100% in all aspects of the Pap test Skills Checklist. Please note that #15 on the checklist may not be appropriate in some clinical settings in which case the Preceptor would mark “N/A” and exclude this from the performance criteria.

RN: _____

Preceptor: _____

CRITICAL ELEMENTS to Pap Testing Performance (Performs examination according to clinic/agency policies and procedure)	Date	Date	Date	Date
1. Proceeds if health history indicates. Refers client if there are concerns identified in the health history				
2. Explains procedure correctly and validates plan with client (informed verbal consent)				
3. Checks with client to determine if she needs to empty her bladder				
4. Discusses with client how she can take an active part in the examination				
5. Assembles necessary supplies				
6. Labels container and completes form correctly				
7. Drapes client correctly				
8. Positions client correctly				
9. Sits on stool at foot of examining table				
10. Dons examination gloves				
11. Explains each step in the examination before it is done				



CRITICAL ELEMENTS to Pap Testing Performance (Performs examination according to clinic/agency policies and procedure)	Date	Date	Date	Date
12. Touches inner thigh with back of hand before touching vulva				
13. Palpates inguinal and femoral area correctly				
14. Inspects the external genitalia correctly				
15. Examines the urethra, Skene's glands, Bartholin's glands correctly <i>*May be N/A</i>				
16. Selects the proper sized speculum				
17. Lubricates the speculum with only warm water				
18. Inserts the speculum correctly so that the cervix is in full view				
19. Locks the speculum blades correctly				
20. Inspects the cervix for colour, position, edema in zone of ectopy, size, shape of os, surface, and cervical secretions				
21. Assesses position of transformation zone correctly				
22. Obtains specimen with spatula correctly <ul style="list-style-type: none"> ✓ Rotates spatula in cervical os only 360° ✓ Ends rotation so spatula is in 3 and 9 o'clock position ✓ Swirls plastic spatula in ThinPrep container vigorously OR drops plastic spatula in the SurePath container 				
23. Obtains specimen with a brush correctly <ul style="list-style-type: none"> ✓ Inserts brush gently all the way into the cervical os to end of bristles ✓ Turn 90° only ✓ Swirls cytobrush in ThinPrep container vigorously OR drops cytobrush in the SurePath container 				
24. Obtains specimen with a broom correctly <ul style="list-style-type: none"> ✓ Inserts broom gently all the way into the cervical os until 				



CRITICAL ELEMENTS to Pap Testing Performance (Performs examination according to clinic/agency policies and procedure)	Date	Date	Date	Date
lateral bristles spread out over the ectocervix ✓ Rotate broom 5 times clockwise ✓ Drops broom in the SurePath container				
25. Removes the speculum correctly				
26. Inspects vaginal wall while removing speculum				
27. Prepares slide/container and completed requisition correctly for transport to laboratory				
28. Assists client out of lithotomy position				
29. Shares results of examination with client				
30. Provides health information and reading resources to client				
31. Informs client of how results will be shared				
32. Informs client of when next Pap test is due				
33. Documents results of examination correctly on client's Health Record				
34. Identifies abnormal findings (STI, cervical abnormalities etc.) and promptly consults with or refers client to Physician or Nurse Practitioner				



Client Satisfaction Survey ([download](#))

It is recommended that:

- RNs obtain feedback from clients regarding their performance with Pap testing.
- A feedback process is established in the employing clinic/agency for collecting and responding to client satisfaction surveys.
- The following survey is given to all clients following their visit with the RN conducting unsupervised Pap related visits during the practicum period. (Provide the client with the survey and an envelope, request that the client complete the survey, place it in the envelope and give it to the office staff).
- The collected surveys are used by the RN and Preceptor to assist in feedback and review.

A sample survey is provided below.



CLIENT SATISFACTION SURVEY

Please help us improve our services by answering the following questions about the Pap test service you received. The RN who provided this service is taking part in an evaluation to ensure a high quality of Pap test service for women.

You are asked to complete this survey, but it is voluntary. The survey will take about 3 minutes to complete. All results from surveys are combined so that your anonymity and confidentiality are protected. Do not write your name on this survey, unless you would like to be contacted.

Date: _____

RN Name: _____

	Please check (√) one box for each question					
	Strongly Agree	Agree	Neutral	Disagree	Strongly Disagree	N/A
The RN respected my values, beliefs and culture.						
The RN explained the Pap test to me in words I could understand.						
The RN assured me that the Pap test was confidential.						
The RN asked if it was okay to go ahead with the Pap test.						
The RN made sure I had privacy during the Pap test.						
The RN checked with me during the Pap test to make sure I was comfortable.						
The RN told me how I will get my Pap test results.						
I am satisfied with the services I received.						

What is one thing that the RN did well?

What is one thing that the RN could do better?

If you would like to be contacted by the clinic manager, please write down your name and phone number (optional). Name: _____ Phone Number: _____

Thank you for your feedback.

Please put your completed survey in the envelope provided and return to office staff.



Practicum Audit Form ([download](#))

During the practicum period, the RN will compile results of the supervised and unsupervised Pap tests to calculate their Pap test adequacy rate** for that period.

Adequacy rate can be calculated by compiling all Pap test result letters and counting the number of unsatisfactory Pap tests. Divide the number of unsatisfactory Pap tests by the total number of Pap tests conducted and multiply by 100 to find the adequacy rate (%) during the practicum period.

Below is a worksheet that can be used to track Pap tests performed during the practicum period and compile satisfactory and unsatisfactory results.

****Specimen adequacy rates differ between the labs** based on the type of liquid based cytology that is used and the process for analyzing specimens within the lab.

The Pap Test Specimen Adequacy Rate for Alberta Public Laboratories is <1% (of tests are unsatisfactory).

The Pap Test Specimen Adequacy Rate for DynaLIFE is <2% (of tests are unsatisfactory).

Pap Test Date	Supervised (√)	Unsupervised (√)	Satisfactory (√)	Unsatisfactory (√)
1.	<input type="checkbox"/>	<input type="checkbox"/>	<input type="checkbox"/>	<input type="checkbox"/>
2.	<input type="checkbox"/>	<input type="checkbox"/>	<input type="checkbox"/>	<input type="checkbox"/>
3.	<input type="checkbox"/>	<input type="checkbox"/>	<input type="checkbox"/>	<input type="checkbox"/>
4.	<input type="checkbox"/>	<input type="checkbox"/>	<input type="checkbox"/>	<input type="checkbox"/>
5.	<input type="checkbox"/>	<input type="checkbox"/>	<input type="checkbox"/>	<input type="checkbox"/>
6.	<input type="checkbox"/>	<input type="checkbox"/>	<input type="checkbox"/>	<input type="checkbox"/>
7.	<input type="checkbox"/>	<input type="checkbox"/>	<input type="checkbox"/>	<input type="checkbox"/>
8.	<input type="checkbox"/>	<input type="checkbox"/>	<input type="checkbox"/>	<input type="checkbox"/>
9.	<input type="checkbox"/>	<input type="checkbox"/>	<input type="checkbox"/>	<input type="checkbox"/>
10.	<input type="checkbox"/>	<input type="checkbox"/>	<input type="checkbox"/>	<input type="checkbox"/>
11.	<input type="checkbox"/>	<input type="checkbox"/>	<input type="checkbox"/>	<input type="checkbox"/>
12.	<input type="checkbox"/>	<input type="checkbox"/>	<input type="checkbox"/>	<input type="checkbox"/>
13.	<input type="checkbox"/>	<input type="checkbox"/>	<input type="checkbox"/>	<input type="checkbox"/>
14.	<input type="checkbox"/>	<input type="checkbox"/>	<input type="checkbox"/>	<input type="checkbox"/>
15.	<input type="checkbox"/>	<input type="checkbox"/>	<input type="checkbox"/>	<input type="checkbox"/>
16.	<input type="checkbox"/>	<input type="checkbox"/>	<input type="checkbox"/>	<input type="checkbox"/>
17.	<input type="checkbox"/>	<input type="checkbox"/>	<input type="checkbox"/>	<input type="checkbox"/>
18.	<input type="checkbox"/>	<input type="checkbox"/>	<input type="checkbox"/>	<input type="checkbox"/>
19.	<input type="checkbox"/>	<input type="checkbox"/>	<input type="checkbox"/>	<input type="checkbox"/>
20.	<input type="checkbox"/>	<input type="checkbox"/>	<input type="checkbox"/>	<input type="checkbox"/>
21.	<input type="checkbox"/>	<input type="checkbox"/>	<input type="checkbox"/>	<input type="checkbox"/>
22.	<input type="checkbox"/>	<input type="checkbox"/>	<input type="checkbox"/>	<input type="checkbox"/>
23.	<input type="checkbox"/>	<input type="checkbox"/>	<input type="checkbox"/>	<input type="checkbox"/>
24.	<input type="checkbox"/>	<input type="checkbox"/>	<input type="checkbox"/>	<input type="checkbox"/>
25.	<input type="checkbox"/>	<input type="checkbox"/>	<input type="checkbox"/>	<input type="checkbox"/>

Supervised Pap tests

Unsupervised Pap tests

Satisfactory Results

Unsatisfactory Results

TOTAL: _____

Practicum Specimen Adequacy Rate: Unsats _____ / Total _____ = _____ x 100 = _____ %



APPENDIX 3: ANSWER KEY PRE-TEST AND POST-TEST

Marking Instructions

- Each correct answer scores one mark (i.e. Question #1: 4/4 responses correct = 4 marks, 3/4 responses correct = 3 marks, etc.).
- The RN is required to get 85/100 marks to attain the module requirements for competency (85%).

Pre-test and Post-test Answer Key ([back to Pre-test](#)) ([back to Post-test](#))

1. RNs in Alberta are expected to practice in a manner consistent with:

(ANSWER: SECTION 1 = a, b, c, d)

- Health Professions Act (HPA) (2000; 2005; 2018)*
- CARNA Practice Standards for Regulated Members (2013)*
- CARNA Restricted Activities Standards (2019)*
- Canadian Nurses Association (CNA) Code of Ethics for Registered Nurses (2017)*
- CARNA Cervical Cancer Screening Practice Advice (2018)*

2. The responsibilities of Employers of RNs who are expected to provide Pap tests as part of their position include:

(ANSWER: SECTION 1 = a, b, c, d, e)

- Providing adequate education time, resources, preceptorship opportunities, and facilities.
- Ensuring that there is an explicit relationship with the RN taking the Pap test and a Physician or Nurse Practitioner.
- Developing policies and procedures related to RN Pap testing.
- Participating in ongoing monitoring of Pap test adequacy rates.
- Maintaining a record of RN Pap test education.

3. The cornerstones of women-centered care include which of the following factors?

(ANSWER: SECTION 1 = a, b, c, d)

- A focus on women
- Involvement and participation of women
- Empowerment
- Respect and safety

4. Which of the following is not a risk factor for cervical cancer?

(ANSWER: SECTION 2 = d)

- a. Multiple male sex partners
- b. Early onset of first intercourse
- c. Genital infections such as herpes simplex II (HSV2) and Chlamydia
- d. Family history
- e. HPV infection
- f. Smoking

5. The Alberta Cervical Cancer Screening Program is needed because:

(ANSWER: SECTION 2 = a, c, e)

- a. Organized cervical cancer screening programs reduce the rates of cervical cancer.
- b. Having regular Pap tests may prevent a few cervical cancers.
- c. Supporting women to have regular Pap tests and follow-up care can prevent almost all cervical cancers.
- d. All clients who develop cervical cancer in Alberta have not had regular Pap tests.
- e. More than ½ of the clients who develop cervical cancer in Alberta have not had regular Pap tests.

6. All women between the ages of 25-69 who have ever been sexually active should have Pap tests regularly. (Except women who have had a hysterectomy for benign reasons with no history of biopsy confirmed high-grade lesions or cervical cancer.)

(ANSWER: SECTION 2 = a)

- a. True
- b. False

7. Name four high risk groups in particular who RNs should encourage to have Pap tests regularly.

(ANSWER: SECTION 2 = see list below, need 4 correct)

- Older women
- Women living in poverty
- Immigrant and refugee women
- Un/under-screened ethnocultural or other communities
- Aboriginal women

8. Women older than 69 who have never been screened for cervical cancer need 3 negative and satisfactory routine Pap tests (including a negative HPV reflex test) before screening can be discontinued.

(ANSWER: SECTION 3 = a)

- a. True
- b. False

9. Women younger than 21 who have been sexually active for 3 years need to be screened for cervical cancer.

(ANSWER: SECTION 3 = b)

- a. True
- b. False

10. Which age group is least likely to benefit from increased access to and promotion of Pap testing

(ANSWER: SECTION 3 = d)

- a. Women aged 50 to 69
- b. Women aged 36-49
- c. Women aged 25-35
- d. Women under 21

11. List four reasons why an eligible woman may be reluctant to have a Pap test.

(ANSWER: SECTION 4 = see list below, need 4 correct)

- Lack of information and understanding of cervical cancer screening and Pap tests
- Fear of test
- Fear of cancer
- Fear of pain
- Embarrassment
- Modesty
- Religious and social factors
- Inability to understand an invitation to participate in cervical screening because of language barriers
- Difficulty in communicating with some health professionals
- Lack of childcare facilities
- Other peoples' attitudes to the cervical cancer screening and Pap tests (i.e. husband, family, religious leaders)
- Accessibility issues



12. If a client appears apprehensive before the pelvic exam, it is best to:

(ANSWER: SECTION 4 = c)

- a. Reassure her and press forward
- b. Tell her that there is nothing to worry about
- c. Ask open-ended questions about her apprehension around the Pap test procedure

13. List four key things that should be discussed with the client after the Pap test visit:

(ANSWER: SECTION 4 = see list below, need 4 correct)

- Exam findings
- How client will receive her lab results
- Client questions
- Client education (i.e. written information; ACCSP brochures)

14. List five client groups that may have special learning, counselling and educational needs related to cervical cancer screening.

(ANSWER: SECTION 5: see list below, need 5 correct)

- Younger women
- Lesbians and other sexual minorities
- Clients with a history of sexual abuse
- Clients with disabilities
- Clients from different cultures
- Clients who have undergone female genital mutilation
- Clients with barriers to access

15. Which of the following findings related to STI might be discovered during an external genital examination?

(ANSWER: SECTION 5 = a, b, c, d)

- a. Pubic lice/crabs
- b. Genital warts
- c. Genital herpes
- d. Inflammation of the Bartholin's glands

16. A client presents with the following symptoms:

- Raised painless lesions on the labia, the vestibule, and/or in the perianal region.
- Flesh-colored cluster of soft growths.

(ANSWER: SECTION 6 = d)

The client most likely has:

- a. Molluscum contagiosum
- b. Nabothian follicles
- c. Genital herpes
- d. Genital warts
- e. Yeast infection

17. List six abnormal findings of the ectocervix:

(ANSWER: SECTION 6= see list below, need 6 correct)

- Abnormal exudates or masses upon the ectocervix
- Asymmetrical circumoral erythema with irregular borders
- Blood of unknown origin
- Cyanosis in a nonpregnant client
- Diffuse erythema
- Excavations or ulcerations
- Nodularity or roughness is usually abnormal, but may be attributable to nabothian cysts which are common
- Hemorrhagic lesions
- Leukoplakia

18. Which of the following are abnormal findings on the cervix that should be referred to a Physician or Nurse Practitioner?

(ANSWER: SECTION 6=a, b, c, d)

- a. Friable tissue (soft, eroded)
- b. Red patchy areas
- c. Abnormal bleeding and inflammation
- d. Granular areas, white patches
- e. Pink colour

19. Name the three sampling areas of the cervix.

(ANSWER: SECTION 6 = see list below, need 3 correct)

- Ectocervix
- Endocervix
- Transformation zone

20. A client reports that they completed their complete set of HPV immunization vaccines and questions if they should have a Pap test. What is the correct response?

(ANSWER: SECTION 2 = d)

- The client does not need to have a Pap test for five years after immunization.
- The client is immunized and no longer requires Pap tests in their lifetime.
- The client only requires Pap tests if they are symptomatic.
- It is very important the client still gets regular Pap test screening even if they have been vaccinated.

21. Women due for a Pap test who are pregnant or who have had a total or subtotal hysterectomy due to biopsy confirmed high-grade lesions or cervical cancer should be referred to a Physician, Nurse Practitioner (or Registered Midwife) for a Pap test.

(ANSWER: SECTION 8 = a)

- True
- False

22. A smaller and narrower speculum should be used with:

(ANSWER: SECTION 8 = a, b, c, d)

- Clients who have not engaged in full vaginal penetration during sexual activity
- Nulliparous clients
- Circumcised clients
- Clients whose vaginal orifices have contracted postmenopausally

23. It is acceptable to lubricate the speculum with:

(ANSWER: SECTION 8 = b)

- a. A very small amount of water soluble lubricant
- b. Warm water
- c. Vaseline

24. An acceptable way to insert the speculum is:

(ANSWER: SECTION 8 = b, c, e)

- a. Blade tips against the upper (anterior) wall of the vagina.
- b. At an oblique angle.
- c. With the speculum closed.
- d. With the speculum slightly opened.
- e. With the speculum angled 45° downward toward the small of the client's back.

25. The best way to reposition a speculum for a client with a cervix with posterior orientation is:

(ANSWER: SECTION 8 = b)

- a. Reinsert less deeply and anteriorly, with the base of the lower blade actually compressing the anterior wall of the vagina.
- b. Insert the speculum more deeply and posteriorly through compression of the perineal tissue. The blade tips will slip under the cervix into the posterior fornix.
- c. Choose a plastic speculum of a larger size and reinsert as you did prior.

26. What are the ideal client conditions for cervical screening?

(ANSWER: SECTION 9 = a, b, c, d)

- a. Avoidance of vaginal douching for 24 hours before the test.
- b. Avoidance of use of contraceptive creams or jellies for 24 hours before the test.
- c. Avoidance of intercourse for 24 hours before the test.
- d. Mid-cycle.
- e. During menses.

27. The correct way to obtain an ectocervix specimen with spatula is:
(ANSWER: SECTION 9 = a)

- a. Rotate spatula in cervical os only 360° and end rotation so spatula is in 3 and 9 o'clock position.
- b. Rotate spatula in cervical os only 180° and end rotation so spatula is in 3 and 9 o'clock position.
- c. Rotate spatula in cervical os only 90° and end rotation so spatula is in 3 and 9 o'clock position.

28. The correct way to obtain a specimen with a cytobrush is:

(ANSWER: SECTION 9 = a)

- a. Insert the cytobrush gently all the way into the cervical os but no further than the end of the bristles and turn 90° to 180°.
- b. Insert the cytobrush gently all the way into the cervical os but no further than the end of the bristles and turn 180° and back again.
- c. Insert the cytobrush gently all the way into the cervical os but no further than the end of the bristles and turn 360°.

29. The correct way to obtain a specimen with a broom is:

(ANSWER: SECTION 9 = c)

- a. Insert the broom gently all the way into the cervical os until the lateral bristles splay out across the ectocervix and turn the broom in a clockwise circle once.
- b. Insert the broom gently all the way into the cervical os until the lateral bristles splay out across the ectocervix and turn the broom in three clockwise circles.
- c. Insert the broom gently all the way into the cervical os until the lateral bristles splay out across the ectocervix and turn the broom in five clockwise circles.

30. Over rotation of the endocervical brush will cause cell damage and slight capillary bleeding.

(ANSWER: SECTION 9 = a)

- a. True
- b. False

31. Unsatisfactory Pap tests are mostly a result of the following:

(ANSWER: SECTION 10 = a, b)

- a. Cervical sampling issues
- b. Specimen collection issues

32. List six key descriptions that could be documented following a Pap test visit:

(ANSWER: SECTION 11 = see list below, need 6 correct)

- Ease of examination
- Specimens that were obtained
- Abnormalities noted
- Condition of labia, cervix, vagina, and any deviations to normal (describe)
- Clients response to exam (anything abnormal that made you think sexual abuse)
- Discharge teaching and follow-up

33. During a Pap test visit, when does the RN seek to obtain informed verbal consent from the client?

(ANSWER: SECTION 8 & 11= b)

- a. At the start of the consultation.
- b. After you have explained the external exam, speculum exam and the Pap test procedure and before you begin.
- c. After completing the external exam, speculum exam and the Pap test.

34. Is the RN legally responsible to protect confidentiality of client health information?

(ANSWER: SECTION 11 = a)

- a. Yes
- b. No

35. An informal verbal agreement between an RN and a Physician or Nurse Practitioner should be used to outline the RN's role in performing Pap tests.

(ANSWER: SECTION 1 & 11 = b)

- a. True
- b. False

APPENDIX 4: ANSWER KEY CASE STUDIES

Marking Instructions

- Each question answered by at least 1 appropriate response scores one mark (i.e. Question #1: 1 appropriate response = 1 mark, 2 appropriate responses (if applicable) = 2 marks, etc.).
- The RN is required to get 17/20 marks to attain the module requirement for competency (85%).

Case Study #1

A 28 year old low income client presents to an active treatment centre in her community. She has had 3 pregnancies in 4 years, a history of 1 spontaneous abortion, 1 termination at 15 weeks and 1 live birth. She states that she doesn't want her male doctor to examine her and she thinks she may be pregnant. The doctor tells the RN that the client had an abnormal Pap test 3 years ago. There is no history on the file as the client has different doctors in the area. The client is adamant that she wants a female examiner, knows there is a trained RN on site and refuses to leave if she isn't examined. She has an extensive history of "no-show" appointments and may or may not have problems with abuse of alcohol and drugs.

1. What are your first priorities for this client?
 - Consent for treatment and sharing of information. Education, confidence and trust building are the most important priorities.
 - Pregnancy test.
2. What information do you need to proceed?
 - Results from previous tests.
 - Results from pregnancy test.
 - Confirm who the client's previous doctors were.
3. What might your legal/ ethical, scope of practice issues be? How should you proceed?
 - You may or may not be able to perform a Pap test or any STI testing depending on your clinic/agency policy on pregnant clients.
 - If client is under the influence of drugs informed consent may be an issue.
 - As she may leave, get a good history as well as all information for follow-up as she may be difficult to find.
 - If you are unable to perform Paps on pregnant clients, discuss if she would be more comfortable visiting a Physician for Pap test, and prenatal (if required) follow-up if a female companion or RN was present.
 - If drugs or alcohol is a factor, but the situation is volatile, try to discuss her basic health needs, resources in the community etc. Encourage her to return and at subsequent visits encourage referral for substance abuse counselling.

Case Study #2

A 52 year old female client presents at a large urban health centre. During the health history, she states that she has some itchiness and watery vaginal discharge. On performing a speculum examination you note that the vagina is red and granular looking. There is a frothy yellowish foul-smelling vaginal discharge.

1. What may be causing the above symptoms?
 - Possibly trichomonas
2. Outline the plan of care you will discuss with this client.
 - Pap test deferred until inflammation has settled down.
 - Possibility of a STI and the need to see Physician or Nurse Practitioner for STI testing.
 - Need to test and treat partner(s) if it is a STI.
3. Outline your educational and counselling strategies with this client.
 - STI risk and prevention.
 - Need for safer sex practices until STI testing and treatment is complete
 - Reinforce use of male or female condoms with regular birth control methods (e.g. pill, patch, depoprovera).
 - Help client create a plan for initiation and maintenance of STI prevention.
 - Need for regular Pap tests.
 - Answer questions.
 - Provide literature on vaginitis, STI risks and prevention, and Pap test.

Case Study #3

25 year old aboriginal client presents at a Well Baby clinic on a reserve community. She has her husband and a 4 month old baby with her and has a 2 and 3 year old at home. She is trying to get pregnant again. Discussion ensues as to her plan for a pregnancy so soon after this birth. She is slow to answer. The husband finally says that his wife has been told that she had an "abnormal cancer test" during her last pregnancy and that she was referred to the Women's Centre at her 6 week postpartum doctor's visit. She did not attend the postpartum doctor's visit because she is afraid that she has cancer "down there". The client wants to have more babies before she has surgery. The client and her husband both think she will have her "womb taken out".

1. What is the first priority for this client?
 - Refer to a Physician, Nurse Practitioner, or Registered Midwife.
 - If required, get consents for examination and release and sharing of information.
2. Should the RN do cervical screening?
 - No, if possible refer to a Physician, Nurse Practitioner, or Registered Midwife, but stay involved as this couple will require good education and the team commitment to ensure appropriate care.
 - Education and follow-up is important.

Case Study #4²

A 38 year old female client presents in Well Women's Clinic. On taking her health history you note that she has not menstruated for a couple of months but she indicates that her periods are often irregular and she doesn't think that she is pregnant. She has never had a Pap test and agrees to have one done today. On performing a speculum examination you note a bluish discolouration of the cervix. There is also a thin, creamy, gray-white, vaginal discharge. There is no inflammation on the vaginal wall or cervix.

1. What may be causing the discolouration of the cervix?
 - Possible pregnancy
2. What may be causing the vaginal discharge?
 - Likely bacterial vaginosis
3. How would you proceed?
 - Perform a pregnancy test.
 - If client is pregnant, refer to for follow-up care.
4. Outline your educational and counselling strategies with this client.
 - Information about bacterial vaginosis.
 - Need for follow-up with Physician, Nurse Practitioner, or Registered Midwife for treatment and follow-up of symptoms.
 - Discuss STI risk and prevention with client.
 - Reinforce use of male or female condoms with regular birth control methods (e.g. pill, patch, Depo-Provera).
 - Need for regular Pap tests.
 - Answer questions.

Case study #5

A 62 year old aboriginal client presents for her Pap test. She has not been in for regular screening in the past. The client is very self-conscious about her body as she believes that she is overweight. She has developed a good trusting relationship with her RN who has recently been certified to do cervical screening. The history is taken and there are no signs to indicate that this will be anything other than a routine screening. Upon examination the client becomes tense and somewhat upset. The RN has trouble finding the clients cervix. The client continues to become more anxious and starts to cry, saying that the examination is painful.

1. What is the first priority for this client?
 - Prior to starting, continue to build on the positive relationship.
 - Obtain detailed history.
 - Discuss any concerns before the exam. Overweight or very tense clients pose a challenge and may be more difficult to examine.
2. With a nervous client, what are some ideas to promote comfort?
 - Provide the client the opportunity to look at the equipment.
 - Facilitate the client to retain her modesty by allowing her to leave on as many clothes as possible, including her shoes if she desires.
 - Ensure a comfortable examination.
 - Try an exam position that is most comfortable for the client.
 - If she hasn't emptied her bladder, have her void or empty again as this can increase her anxiety.
3. When the client starts to cry, what should you do?
 - Stop the exam and discuss how she wants to proceed.
 - Change this size of the speculum if required.
 - Assess with if the speculum is too warm or cold? Check this with the client and after she is ready to proceed, proceed slowly.
4. The cervix is pink and fleshy, but has some "bumps on it. What might this be and what should you do?
 - May be nabothian follicles but assess appropriately to determine if they look like genital warts.

Case study #6

You work in a low socioeconomic inner city practice with multiple immigrant women, many of whom do not have English as a first language. A 65 year old client of East Indian background attends your office for the first time to get her blood pressure checked. She is a smoker. She has moved to stay with her son and help look after her grandchildren. She is mildly obese. She says that she has had no Pap since having children (the last child was born 45 years ago), that she has only rare sexual activity with her husband of many years and why would she need a Pap.

She still has periods each month but they are getting heavier and closer together, i.e. q 3 weeks. When asked about previous Pap tests she said, "I had a few when I was younger, in my 20's and they said one was abnormal, so I had to have more frequent examinations at the Physician's office". She says that she really doesn't want any more Pap tests.

1. What if this client had had a hysterectomy, how would you deal with the idea of doing a Pap test?
 - Refer clients with total or subtotal hysterectomy due to biopsy confirmed high-grade lesions or cervical cancer to their Physician or Nurse Practitioner for follow-up. Women who have had a total hysterectomy for benign reasons (e.g. endometriosis) do not need to continue with their Pap tests.
2. What else would you like to know about this client, particularly in regard to her risk for cervical cancer?
 - Chief complaint at this time, past history.
3. How would you discuss the risk of cervical cancer with her?
 - Discuss relevant risk factors – e.g. current smoking, history of abnormal Pap tests, lack of regular Pap tests.
 1. What if she agrees to have a basic assessment (e.g. blood pressure) but still refuses a Pap test - what would you do?
 - Gradually build up her trust in you and deal with the issues she has identified initially.
 - Discuss necessity of Pap test and ways to improve her comfort (e.g. having a companion/interpreter present during the exam).
 - May be helpful to explore language barriers and the meaning of the Pap test to her? Assess if there are any abuse issues that might pose doing a Pap test challenging for her and you?

APPENDIX 5: EVALUATION

Please complete the following survey and send responses to:

Mail: Alberta Health Services - Screening Programs
2210-2nd St. S.W. Calgary, Alberta Canada T2S 3C3

E-mail: ACCSP@albertahealthservices.ca **Fax:** 1-888-944-3388

Learning Module Evaluation ([download](#))

Please complete the following evaluation of the **Learning Module** to help improve future revisions.

Questions below use the following scale:

1 = Strongly Disagree, 2 = Disagree, 3 = Neutral, 4 = Agree, 5 = Strongly Agree

Please comment on any 'disagree' ratings to further support continuous improvement.

- | | | | | | |
|--|---|---|---|---|---|
| 1. I achieved the learning module goals and objectives. | 1 | 2 | 3 | 4 | 5 |
| Explain: _____ | | | | | |
| 2. The learning module content increased my knowledge of cervical cancer, cervical cancer screening, and Pap testing techniques. | 1 | 2 | 3 | 4 | 5 |
| Explain: _____ | | | | | |
| 3. The recommended readings increased my knowledge of cervical cancer, cervical cancer screening, and Pap testing techniques. | 1 | 2 | 3 | 4 | 5 |
| Explain: _____ | | | | | |
| 4. The Pre/Post-Tests helped me to assess my knowledge and areas of improvement. | 1 | 2 | 3 | 4 | 5 |
| Explain: _____ | | | | | |
| 5. The Case Studies enhanced my learning regarding sensitive approaches to client examination and counselling. | 1 | 2 | 3 | 4 | 5 |

Explain: _____

6. The Assessment Tools were useful in assessing my skills and competencies. 1 2 3 4 5

Explain: _____

7. What did you find MOST useful about the learning module?

8. What did you find NOT useful about the learning module?

9. What other information would be helpful to include in this module?

Do you consent to AHS contacting you directly to help us evaluate the Learning Module?

Yes ___ No ___ If Yes, please write down your contact information below:

Name _____ Phone # _____

Email address _____

Thank you for completing Part A of this evaluation.

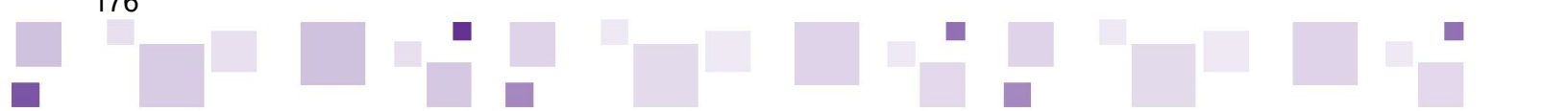

Practicum Evaluation ([download](#))

Please complete the following evaluation of the **Practicum** to help improve future RN practicum experiences.

Questions below use the following scale:

1 = Strongly Disagree, 2 = Disagree, 3 = Neutral, 4 = Agree, 5 = Strongly Agree

Please comment on any 'disagree' ratings to further support continuous improvement.

1. My practicum objectives were met. 1 2 3 4 5

Explain: _____

2. I had the opportunity to participate in a variety of clinical situations. 1 2 3 4 5

Explain: _____

3. I was given the opportunity to discuss any issues raised during my practicum. 1 2 3 4 5

Explain: _____

4. I had the opportunity to develop adequate assessment skills. 1 2 3 4 5

Explain: _____

5. I had the opportunity to develop adequate physical exam, speculum exam, and Pap test skills. 1 2 3 4 5

Explain: _____

6. I had the opportunity to develop adequate counselling and education skills. 1 2 3 4 5

Explain: _____

7. Overall the Pap test practicum was valuable. 1 2 3 4 5

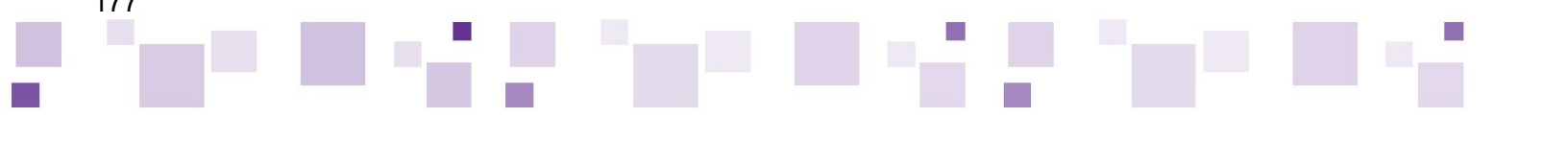

Explain: _____

8. What did you find MOST useful about the practicum?

9. What did you find NOT useful about the practicum?

10. What other information would be helpful to prepare Preceptors?

Thank you for completing Part B of this evaluation.

Thank you for taking the time to complete the evaluation. Your feedback is valuable to us.

